

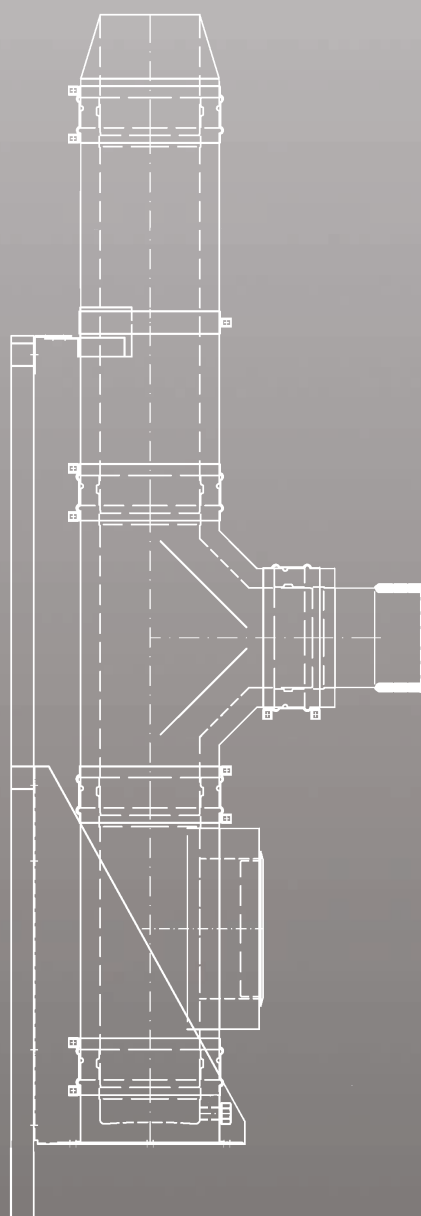

Komínové systémy



CENNÍK – PRICE LIST

Maloobchodný cenník bez DPH.

www.igc.sk



I.G.C. STROJAL s.r.o. bol poverený, certifikovaný a vyhovel požiadavkám EN ISO 9001:2008

The management system of I.G.C. STROJAL s.r.o. has been assessed and certified as meeting the requirement of EN ISO 9001:2008

Vyhlasenie o parametroch pre komínový trojvrstvový systém Kaminodur ERS a EAD z nehrdzavejúcej ocele, pre teplotnú triedu T400

Declaration of performance 3-layer chimney system with stainless steel lining Kaminodur ERS and EAD-temperature class T400



ES certifikát vnútro podnikovej kontroly 1301-CPR-0742 pre stavebný výrobok komínový systém IGCS z Al podľa EN 1856-1 a EN 1856-2

ES certificate of factory production control 1301-CPR-0742 it has been stated that the Chimney system IGCS made of Aluminium pursuant to EN 1856-1 and EN 1856-2

Vyhlasenie o parametroch pre komínové vložky a dymovody z nehrdzavejúcej ocele Kaminodur SRS/AGS, pre teplotnú triedu T400/T200

Declaration of performance rigid flue liners and connecting pipes made from stainless steel Kaminodur SRS/AGS, temperature class T400/T200



Vyhlasenie o parametroch pre komínový systém IGCS s plastovými vložkami, pre teplotnú triedu T120

Declaration of performance IGCS chimney system with plastic liners-temperature class T120



Vyhlasenie o parametroch pre komínový systém IGCS z Al, pre teplotnú triedu T200

Declaration of performance IGCS chimney system in Al metal-temperature class T200



Vyhlasenie o parametroch pre komínový systém IGCS z Al, pre teplotnú triedu T300

Declaration of performance IGCS chimney system in Al metal-temperature class T300

02	<p>KOMPONENTY JEDNOVRSTVOVÝCH DYMOVODOV PRE KONDENZAČNÚ TECHNIKU-PPs-teplotná trieda T120 <i>Komponenty jednovrstvého odkouření pro kondenzační techniku-PPs-teplotní třída T120</i> <i>Single-layer flue system components for condensing gas boilers-PPs-temperature class T120</i> <i>Abgaskomponente für die Kondensationstechnik-PPs-Temperaturklasse T120</i> <i>Egyfalú füstgázvezető rendszer kondenzációs gázkazánokhoz-PPs-hőmérsékleti osztály T120</i></p>	PPs-T120
17	<p>KOMPONENTY KONCENTRICKÝCH DYMOVODOV PRE KONDENZAČNÚ TECHNIKU-PPs/AL-teplotná trieda T120 <i>Komponenty koaxiálního odkouření pro kondenzační techniku-PPs/AL-teplotní třída T120</i> <i>Concentric flue system components for condensing gas boilers-PPs/AL-temperature class T120</i> <i>Konzentrische Luft-Abgas-Systeme für Kondensationssysteme-PPs/AL- Temperaturklasse T120</i> <i>Koncentrikus füstgázvezető rendszer kondenzációs gázkazánokhoz-PPs/AL-hőmérsékleti osztály T120</i></p>	PPs/AL-T120
29	<p>KOMPONENTY JEDNOVRSTVÝCH DYMOVODOV-AL-teplotná trieda T200 <i>Komponenty odkouření-AL-teplotní třída T200</i> <i>Gas flue system components-AL-temperature class T200</i> <i>Einwandkomponente-AL-Temperaturklasse T200</i> <i>Egyfalú füstgázvezető rendszer-AL-hőmérsékleti osztály T200</i></p>	AL-T200
37	<p>KOMPONENTY KONCENTRICKÝCH DYMOVODOV-AL/AL-teplotná trieda T200 <i>Komponenty koaxiálního odkouření-AL-teplotní třída T200</i> <i>Concentric gas flue system components-AL-temperature class T200</i> <i>Konzentrische Abgaskomponente AL/AL-Temperaturklasse T200</i> <i>Koncentrikus füstgázvezető rendszer-AL-hőmérsékleti osztály T200</i></p>	AL/AL-T200
45	<p>KOMPONENTY DYMOVODOV PRE PRIEMYSELNÉ VYKUROVANIE-AL a AL/AL-teplotná trieda T300 <i>Komponenty odkouření pro průmyslové vytápění-AL a AL/AL-teplotní třída T300</i> <i>Gas flue components for industrial heating system-AL and AL/AL-temperature class T300</i> <i>Konzentrische Abgaskomponente AL/AL-Temperaturklasse T200</i> <i>Füstgázvezető rendszer ipari fűtési rendszerhez-AL és AL/AL- hőmérsékleti osztály T300</i></p>	AL-T300
56	<p>KOMPONENTY DYMOVODOV-INOX JEDNOVRSTVOVÝ SYSTÉM KAMINODUR SRS <i>Komponenty odkouření- INOX jednovrstvový systém Kaminodur SRS-teplotní třída T400</i> <i>Insulated concentric flue system components-INOX single-layer system Kaminodur SRS-temperature class T400</i> <i>Abgaskomponente gedämmt-INOX einschichtiges system Kaminodur SRS -Temperaturklasse T400</i> <i>füstgázvezető rendszer-INOX egyrétegű rendszer Kaminodur SRS-hőmérsékleti osztály T400</i></p>	INOX SRS
68	<p>KOMPONENTY DYMOVODOV-INOX JEDNOVRSTVOVÝ PRETLAKOVÝ SYSTÉM KAMINODUR AGS <i>Komponenty odkouření- INOX jednovrstvový pretlakový systém Kaminodur AGS-teplotní třída T200</i> <i>Insulated concentric flue system components-INOX single-layer pressurized system Kaminodur AGS</i> <i>-temperature class T200</i> <i>Abgaskomponente gedämmt-INOX Einschichtdrucksystem Kaminodur AGS-Temperaturklasse T200</i> <i>füstgázvezető rendszer-INOX egyrétegű, zúlnyomásos rendszer alatt álló rendszer Kaminodur AGS-hőmérsékleti</i></p>	INOX AGS
82	<p>KOMPONENTY DYMOVODOV-INOX TROJVRSTVOVÝ SYSTÉM KAMINODUR ERS/EAD <i>Komponenty odkouření- INOX trojvrstvový systém Kaminodur ERS/EAD-teplotní třída T400/T200</i> <i>Insulated concentric flue system components-INOX three-layer system Kaminodur ERS/EAD-temperature class T400/T200</i> <i>Abgaskomponente gedämmt-INOX Dreischichtsystem Kaminodur ERS/EAD-Temperaturklasse T400/T200</i> <i>Szigetelt füstgázvezető rendszer-INOX háromrétegű Kaminodur ERS/EAD rendszer-hőmérsékleti osztály T400/T200</i></p>	INOX ERS/EAD
104	<p>KOMPONENTY DYMOVODOV-INOX TROJVRSTVOVÝ SYSTÉM PPs/INOX <i>Komponenty odkouření-izolované-PPs/INOX-teplotní třída T120</i> <i>Insulated concentric flue system components-PPs/INOX-temperature class T120</i> <i>Abgaskomponente gedämmt-PPs/ INOX-Temperaturklasse T120</i> <i>Szigetelt füstgázvezető rendszer-PPs/INOX-hőmérsékleti osztály T120</i></p>	PPs/INOX

PPs

komponenty | components | komponente | alkotó elemek
 biela | white | weiss | fehér színben

EN 14 471-T120-P1-O-W-1-O10-I-E-L



Komponenty dymovodov pre kondenzačnú techniku – PPs - teplotná trieda T120

RÚRA | TRUBKA | STRAIGHT ELEMENT | ROHR | CSŐ

PPs - T120

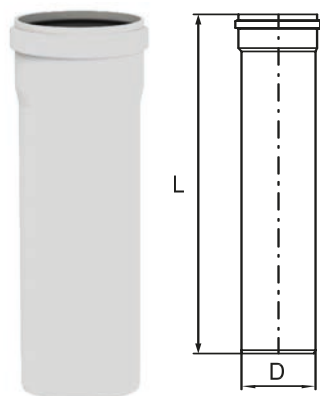

L [mm]	D [mm]	60	80	100	110	125	160	200
250	kód	P102A	P102B	P102C	P102G	P102D	P102H	P102N
	+	3,50/94	4,50/122	6,20/167	6,40/173	8,50/230	9,80/265	29,00/797
500	kód	P105A	P105B	P105C	P105G	P105D	P105H	P105N
	€/Kč	4,70/127	5,80/157	9,00/244	8,20/222	11,10/300	15,50/418	47,00/1271
1000	kód	P110A	P110B	P110C	P110G	P110D	P110H	P110N
	€/Kč	6,40/173	7,00/190	13,0/364	13,70/370	16,60/449	27,80/752	63,00/1704
2000	kód	P120A	P120B	P120C	P120G	P120D	P120H	P120N
	€/Kč	9,50/261	13,00/352	25,00/677	18,80/508	26,30/712	47,00/1271	92,00/2489

RÚRA ČIERNA-UV-STABILNÁ | TRUBKA ČERNÁ-UV STABILNÍ | STRAIGHT ELEMENT, BLACK, UV-STABLE
 ABGASROHR FLEXIBEL SCHWARZ UV-STABIL | FEKETE CSŐ-UV-STABIL

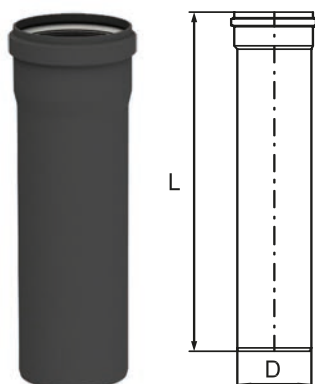

L [mm]	D [mm]	60	80	100	110	125	160	200
250	kód	P202A	P202B					
	€/Kč	4,30/117	5,30/143					
500	kód	P205A	P205B					
	€/Kč	5,60/152	6,10/165					
1000	kód	P210A	P210B	P210C	P210G	P210D	P210H	
	€/Kč	10,00/270	11,00/298	17,00/461	16,00/432	22,50/608	29,00/783	
2000	kód	P220A	P220B					
	€/Kč	20,00/541	21,00/568					

RÚRA FLEXIBILNÁ-BIELA | BÍLÁ FLEXIBILNÍ TRUBKA | FLEXIBLE PIPE-WHITE | ABGASROHR FLEXIBEL WEISS | FEHÉR FLEXIBILIS CSŐ



	D [mm]	60	80	100	110	125
	kód	P110AF	P110BF	P110CF	P110GF	P110DF
L [m]	bajonet	-	✓	✓	-	-
25	€/Kč			13,00/352	16,00/432	22,50/609
50	€/Kč	10,00/270	10,50/284			

cena za 1 m (price for 1 meter)



s bajonetom

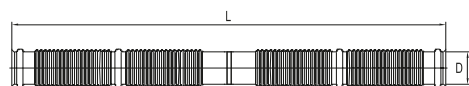

bez bajonetu

PPs

komponenty | components | komponente | alkotó elemek
 biela | white | weiss | fehér színben
 EN 14 471-T120-P1-O-W-1-O10-I-E-L



Komponenty dymovodov pre kondenzačnú techniku – PPs - teplotná trieda T120

RÚRA FLEXIBILNÁ-ČIERNÁ | ČERNÁ FLEXIBILNÍ TRUBKA | FLEXIBLE PIPE-BLACK
 ABGASROHR FLEXIBEL SCHWARZ | FEKETE FLEXIBILIS CSŐ-UV STABIL

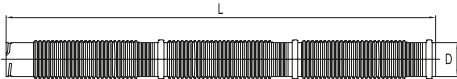

D [mm]	60	80	100	110	125
kód		P210BF			
L [m]	bajonet	✓			
12,5	€/Kč	10,50/284			
25	€/Kč	10,50/284			
50	€/Kč	10,50/284			

cena za 1 m (price for 1 meter)

PPs - T120

TESZENIE | TĚSNĚNÍ | GASKET | DICHTUNG | TÖMÍTŐ GYŰRŰ



D [mm]	60	80	100	125
kód	811AG	813BG	811CG	811DG
€/Kč	1,00/28	1,30/35	2,50/68	3,00/83

RÚRA S REVÍZNYM OTVOROM | TRUBKA S REVÍZNÍM OTVOREM | INSPECTION ELEMENT | KONTOLLROHR | EGYENES ELLENŐRZŐ IDOM

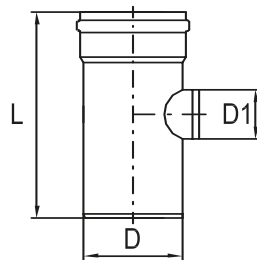

L [mm]	D [mm]	60	80	100
250	kód	P102AD	P102BD	P102CD
	D1 (mm)	60	60	60
	€/Kč	12,00/324	12,00/324	19,50/527

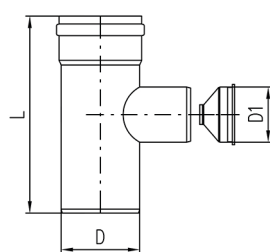

L [mm]	D [mm]	110	125	160	200
250	kód	P102GD3	P102DD3	P102HD3	P102ND3
	D1 (mm)	80	80	100	100
	€/Kč	29,00/784	39,00/1055	54,00/1462	72,00/1948

PPs

komponenty | components | komponente | alkotó elemek
 biela | white | weiss | fehér színben

EN 14 471-T120-P1-O-W-1-O10-I-E-L



Komponenty dymovodov pre kondenzačnú techniku – PPs - teplotná trieda T120

KOLENÁ | KOLENA | ELBOWS | STECKBOGEN | KÖNYÖKÖK

PPs - T120

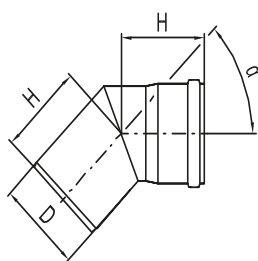

α	D [mm]	60	80	100	110	125	160	200
15°	kód		P115BO		P115GO	P115DO	P115HO	P115NO
	H (mm)		85		103	124	164	170
	€/Kč		4,70/127		9,00/243	14,80/400	16,00/432	55,00/1487
30°	kód		P130BO	P130CO		P130DO	P130HO	P130NO
	H (mm)		85	124		124	164	170
	€/Kč		4,70/127	8,00/216		14,30/387	24,00/649	55,00/1487
45°	kód	P145AO						P145NO
	H (mm)	80						170
	€/Kč	5,70/154						55,00/1489

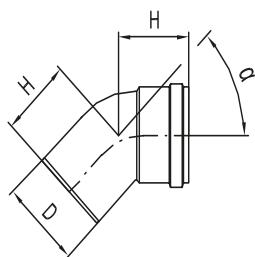

α	D [mm]	80	100	110	125	160
45°	kód	P145BO	P145CO	P145GO	P145DO	P145HO
	H (mm)	80	100	100	100	120
	€/Kč	3,90/106	6,80/183	7,10/192	12,60/340	20,50/555

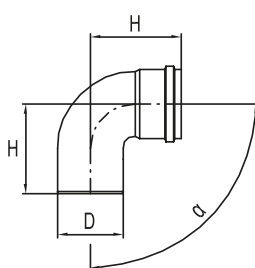

α	D [mm]	60	80	100	110
90°	kód	P190AO			
	H (mm)	120			
	€/Kč	4,80/130			
93°	kód		P190BO	P190CO	P190GO
	H (mm)		110	120	130
	€/Kč		3,90/106	6,80/183	8,00/216

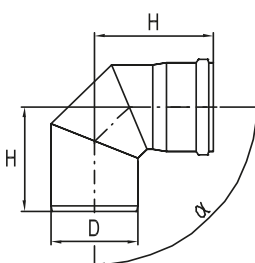

α	D [mm]	125	160	200
90°	kód		P190HO	P190NO
	H (mm)		175	275
	€/Kč		24,649	72,00/1948
93°	kód	P190DO		
	H (mm)	133		
	€/Kč	15,00/406		

PPs

komponenty | components | komponente | alkotó elemek
 biela | white | weiss | fehér színben
 EN 14 471-T120-P1-O-W-1-O10-I-E-L



Komponenty dymovodov pre kondenzačnú techniku – PPs - teplotná trieda T120

KOLENÁ S KONZOLOU | KOLENA S KONZOLOU | CHIMNEY SUPPORT ELBOW | BOGEN MIT STÜTZFUSS | TALPAS KÖNYÖKÖK

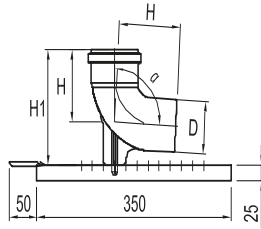

α	D [mm]	80
93°	kód	P192BKZ
	H (mm)	110
	H1 (mm)	175
	€/Kč	13,80/359



α	D [mm]	80
93°	kód	P290BKZ
	€/Kč	27,00/730

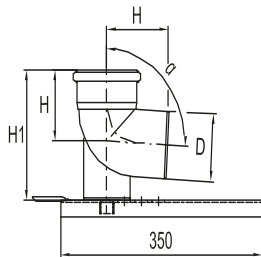

α	D [mm]	100	110	125	160
93°	kód	P190CKZ	P190GKZ	P190DKZ	
	H (mm)	120	130	133	
	H1 (mm)	200	220	240	
	€/Kč	29,00/787	42,00/1135	45,00/1218	
90°	kód				P190HKZ
	H (mm)				175
	H1 (mm)				295
	€/Kč				72,00/1948

PPs - T120



PPs

komponenty | components | komponente | alkotó elemek
 biela | white | weiss | fehér színben
 EN 14 471-T120-P1-O-W-1-O10-I-E-L



Komponenty dymovodov pre kondenzačnú techniku – PPs - teplotná trieda T120

T-KUS S KONZOLOU | STARTING T-PIECE WITH SUPPORT | T-STÜCK MIT AUFLAGER | T-IDOM KONZOLAL

PPs - T120

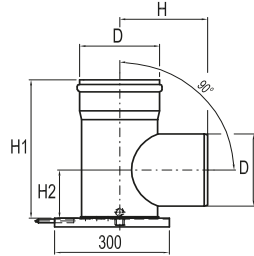

α	D [mm]	200
90°	kód	P521NKZ
	H (mm)	230
	H1 (mm)	380
	H2 (mm)	130
	€/Kč	88,00/2380

KOLENÁ S REVÍZNYM OTVOROM | KOLENÁ S REVÍZNÍM OTVOREM | ELBOW WITH INSPECTION
 KONTROLLBOGEN | ELLENŐRZŐ KÖNYÖKÖK

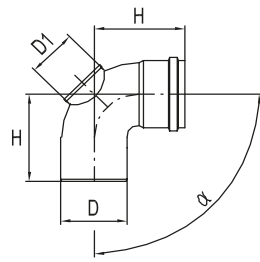

α	D [mm]	60
90°	kód	P190AD
	D1 (mm)	57
	H (mm)	120
	€/Kč	14,00/378

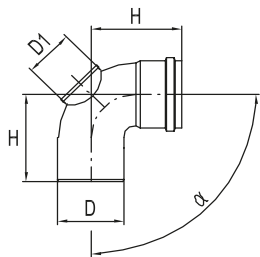

α	D [mm]	80
93°	kód	P192BD
	D1 (mm)	54
	H (mm)	110
	€/Kč	16,00/432

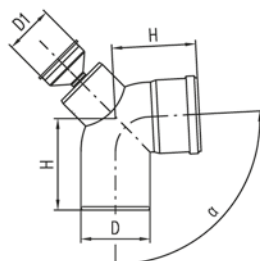

α	D [mm]	100	110
93°	kód	P190CD3	P190GD3
	D1 (mm)	80	80
	H (mm)	120	130
	€/Kč	25,00/677	26,00/703
90°	kód		
	D1 (mm)		
	H (mm)		
	€/Kč		

PPs

komponenty | components | komponente | alkotó elemek
 biela | white | weiss | fehér színben
 EN 14 471-T120-P1-O-W-1-O10-I-E-L



Komponenty dymovodov pre kondenzačnú techniku – PPs - teplotná trieda T120

KOLENÁ S REVÍZNYM OTVOROM | KOLENÁ S REVÍZNÍM OTVOREM | ELBOW WITH INSPECTION
 KONTROLLBOGEN | ELLENŐRZŐ KÖNYÖKÖK

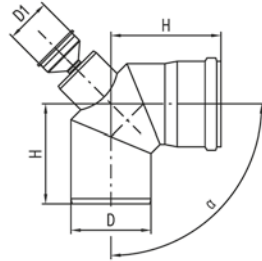

α	D [mm]	125	160	200
90°	kód		P190HD3	P190ND3
	D1 (mm)		100	100
	H (mm)		175	275
	€/Kč		64,00/1731	88,00/2380
93°	kód	P190DD3		
	D1 (mm)	80		
	H (mm)	133		
	€/Kč	48,00/1297		

PPs - T120

T-KUS | T-KUS | T-ELEMENT | T-STÜCK | T-IDOMOK



α	D [mm]	60	80	100	110	125	160	200
90°	kód	P521AT	P521BT	P521CT	P521GT	P521DT	P521HT	P521NT
	H (mm)	110	110	120	135	150	160	230
	L (mm)	216	250	250	330	330	330	500
	L1 (mm)	113	125	125	165	165	155	250
	€/Kč	10,00/270	10,50/284	19,90/539	27,00/730	44,00/1190	55,00/1489	79,20/2142

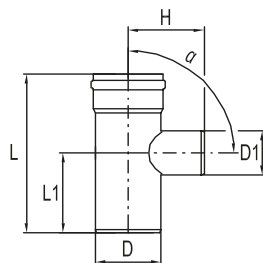
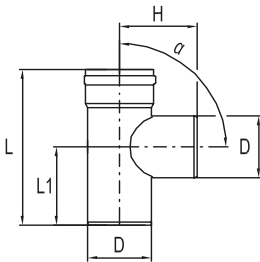

α	D1 [mm]	D [mm]	60	80	100	110	125	160
90°	80	kód				P521BGT	P521BDT	P521BHT
		H (mm)				135	120	140
		L (mm)				250	250	330
		L1 (mm)				125	125	165
		€/Kč	*	*	*	*	45,00/1216	55,00/1353

* cena na vyžiadanie

α	L [mm]	D [mm]	110	125	160	200	110	125	160	200
45°	1000	kód	P145BGT	P145BDT	P145BHT	P145BNT	P145GBT	P145GDT	P145GHT	P145GNT
		D1 (mm)	80	80	80	80	110	110	110	110
		L1 (mm)	195	190	170	155	170	190	170	150
		L2 (mm)	180	195	220	245	220	220	255	280
		€/Kč	45,00/1215	51,00/1379	55,00/1489	77,10/2083	45,00/1215	51,00/1379	62,00/1678	74,10/2003

PPs

komponenty | components | komponente | alkotó elemek
 biela | white | weiss | fehér színben

EN 14 471-T120-P1-O-W-1-O10-I-E-L



Komponenty dymovodov pre kondenzačnú techniku – PPs - teplotná trieda T120

T-KUS | T-KUS | T-ELEMENT | T-STÜCK | T-IDOMOK

PPs - T120

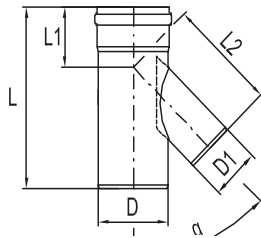

		D [mm]	110	125	160	200
α	L [mm]	kód	P545BGT	P545BDT	P545BHT	P545BNT
		D1 (mm)	80	80	80	80
		L1 (mm)	180	190	170	155
		L2 (mm)	195	190	220	245
		€/Kč	39,00/1053	45,00/1215	55,00/1489	69,00/1866

		D [mm]	110	125	160	200	110	125	160	200	200
α	L [mm]	kód	P545CGT	P545CDT	P545CHT	P545CNT	P545GGT	P545GDT	P545GHT	P545GNT	P545HNT
		D1 (mm)	100	100	100	100	110	110	110	110	160
		L1 (mm)	190	190	170	145	190	190	150	150	130
		L2 (mm)	190	200	230	255	220	220	255	260	320
		€/Kč	39,00/1053	45,00/1215	55,10/1489	69,00/1865	39,00/1053	45,00/1215	55,00/1489	69,00/1866	69,00/1866

T-KUS S UZÁVEROM | T-KUS S UZÁVĚREM | T-PIECE WITH DRAIN CAP
 T-STÜCK MIT KONDENSATABLAUF | T-IDOMOK KONDENZÁTUM GYÚJTÓ EDÉNYEL

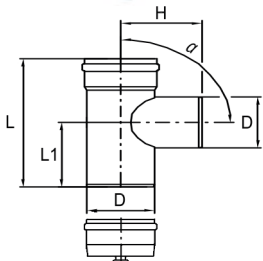

		D [mm]	60	80	100	110	125	160	200
α	kód	P509AK	P509BK	P509CK	P509GK	P509DK	P509HK	P509NK	
		H (mm)	110	110	120	135	150	160	200
		L (mm)	216	250	250	330	330	330	500
		L1 (mm)	113	125	125	165	165	155	250
		€/Kč	17,00/461	17,00/461	29,90/809	42,00/1135	62,00/1677	73,00/1975	128,70/3481

ZACHYTÁVAČ KONDENZÁTU | ZACHYTÁVAČ KONDENZÁTU | CONDENSATE SEPARATOR
 KONDENSATSAMMLER | KONDENZÁTUM LEVÁLASZTÓ

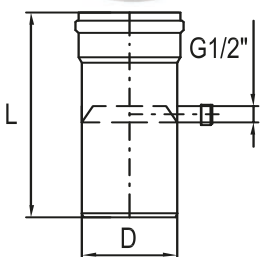

D [mm]	60	80	100	110	125	160	200
kód	P517AN	P517BN	P517CN	P517GN	P517DN	P517HN	P517NN
L (mm)	170	250	250	250	250	250	330
€/Kč	11,50/311	17,50/473	22,00/595	27,00/729	39,00/1054	43,00/1162	59,00/1596

PPs

komponenty | components | komponente | alkotó elemek
 biela | white | weiss | fehér színben
 EN 14 471-T120-P1-O-W-1-O10-I-E-L



Komponenty dymovodov pre kondenzačnú techniku – PPs - teplotná trieda T120

KONDEZAČNÝ UZÁVER | KONDEZAČNÍ UZÁVĚR | CONDENSATION DRAIN CAP
 VERSCHLUSS MIT KONDENSATABLAUF | KONDEZÁTUM GYŰJTŐ EDÉNYEK



D [mm]	60	80	100	110	125	160	200
kód	P552AN	P552BN	P552CN	P552GN	P552DN	P552HN	P552NN
L (mm)	53	55	65	85	90	100	115
€/Kč	7,00/189	8,00/216	10,00/270	19,90/538	22,00/595	29,00/784	51,00/1381

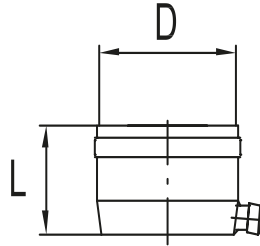
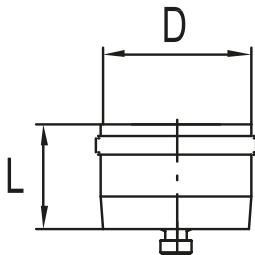

D [mm]	110	125	160	200
kód	P552GNb	P552DNb	P552HNb	P552NNb
L (mm)	85	90	100	115
€/Kč	19,90/538	22,00/595	29,00/784	51,00/1381

REDUKCE | REDUKCE | REDUCER | REDUKTION | BŐVÍTŐK

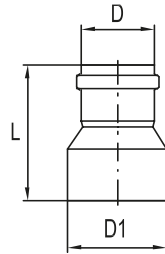

D [mm]	60
kód	P520BR
D1 (mm)	80
L (mm)	120
€/Kč	8,70/235

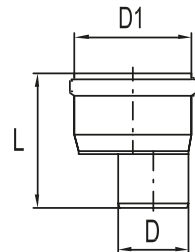

D [mm]	110	110	110	125	125	160	160
kód	P584GDR	P584GHR	P584GNR	P584DHR	P584DNR	P584HNR	P584HQR
D1 (mm)	125	160	200	160	200	200	250
L (mm)	150	200	195	175	195	195	215
€/Kč	27,00/729	36,00/972	58,90/1593	37,00/1000	61,10/1651	63,00/1705	*

* cena na vyžiadanie

D [mm]	60	60	80	80	80	80	80	80	100	100	100	100
kód	P581AR	P584ACR	P584BCR	P584BGR	P584BDR	P584BHR	P584BNR	P584CGR	P584CDR	P584CHR	P584CNR	
D1 (mm)	80	100	100	110	125	160	200	110	125	160	200	
L (mm)	125	160	125	140	150	160	195	145	150	160	195	
€/Kč	6,20/167	17,50/474	25,00/675	25,00/675	25,00/675	33,00/891	49,00/1323	27,00/729	27,00/729	35,00/945	58,90/1593	

PPs

komponenty | components | komponente | alkotó elemek
 biela | white | weiss | fehér színben

EN 14 471-T120-P1-O-W-1-O10-I-E-L



Komponenty dymovodov pre kondenzačnú techniku – PPs - teplotná trieda T120

REDUKCIE | REDUKCE | REDUCER | REDUKTION | BŐVÍTŐK

PPs - T120

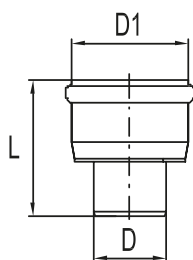

D [mm]	110	110	110	125	125	160
kód	P583GDR	P583GHR	P583GNR	P583DHR	P583DNR	P583HNR
D1 (mm)	125	160	200	160	200	200
L (mm)	150	175	195	175	195	195
€/Kč	27,00/729	36,00/972	58,90/1593	37,00/1000	61,00/1651	63,00/1705

D [mm]	60	60	80	80	80	80	80	100	100	100	100
kód	P580AR	P583ADR	P519BR	P583BGR	P583BDR	P583BHR	P583BNR	P583CGR	P583CDR	P583CHR	P583CNR
D1 (mm)	80	125	100	110	125	160	200	110	125	160	200
L (mm)	165	150	120	140	150	160	195	145	150	175	195
€/Kč	6,20/167	25,00/675	15,80/427	25,00/675	25,00/675	33,00/891	49,00/1323	27,00/729	27,00/729	35,00/945	58,90/1593

KOMÍNY | KOMÍNY | CHIMNEYS | KAMINE | KÉMENYEK

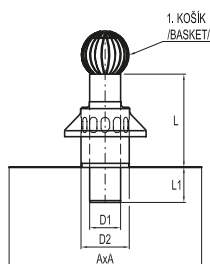

D [mm]	60	80	100	110	125	160
kód	P417ASK	P417BSK	P417CSK	P417GSK	P417DSK	P417HSK
D1 (mm)	60	80	100	110	125	160
D2 (mm)	125	125	150	160	180	225
L (mm)	195	195	195	195	200	200
L1 (mm)	90	90	90	90	90	90
A (mm)	500	500	500	500	500	500
1		✓	✓			
€/Kč	28,00/757	28,00/757	45,00/1170	48,00/1298	54,00/1461	

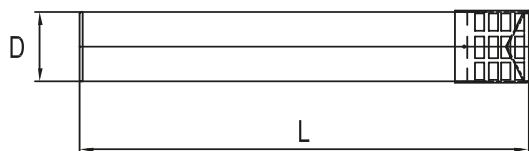

L [mm]	D [mm]	80
1000	kód	P210BH
	€/Kč	17,00/459

PPs

komponenty | components | komponente | alkotó elemek
 biela | white | weiss | fehér színben
 EN 14 471-T120-P1-O-W-1-O10-I-E-L



Komponenty dymovodov pre kondenzačnú techniku – PPs - teplotná trieda T120

KASKÁDY | KASKÁDY | CASCADES | KASKADEN | KASZKÁD BEKÖTÉS

DVOJKOTLOVÁ BEZ SPÄTNÝCH KLAPIEK A UHLOM A=45° | FOR TWO GAS BOILERS (CHECK VALVES NOT INCLUDED)

α	D1 (mm)	D [mm]	110	125	160	200	110	125	160	200
45°	80	kód	KAS P642BG3	KAS P642BD3	KAS P642BH3	KAS P642BN3	KAS P652BG3	KAS P652BD3	KAS P652BH3	KAS P652BN3
		L (mm)	440	440	440	440	940	940	940	940
		€/Kč	*	*	181,00/4897	*	118,00/3192	139,00/3760	168,00/4544	212,00/5735

* cena na vyžiadanie

α	D1 (mm)	D [mm]	110	125	160	200	110	125	160	200
45°	100	kód	KAS P642CG3	KAS P642CD3	KAS P642CH3	KAS P642CN3	KAS P652CG3	KAS P652CD3	KAS P652CH3	KAS P652CN3
		L (mm)	440	440	440	440	940	940	940	940
		€/Kč	*	*	341,00/9224	*	118,00/3192	139,00/3760	168,00/4544	212,00/5735

* cena na vyžiadanie

α	D1 (mm)	D [mm]	110	125	160	200	110	125	160	200
45°	110	kód	KAS P642GG3	KAS P642GD3	KAS P642GH3	KAS P642GN3	KAS P652GG3	KAS P652GD3	KAS P652GH3	KAS P652GN3
		L (mm)	440	440	440	440	940	940	940	940
		€/Kč	*	*	*	*	118,00/3192	139,00/3760	168,00/4544	212,00/5735

* cena na vyžiadanie

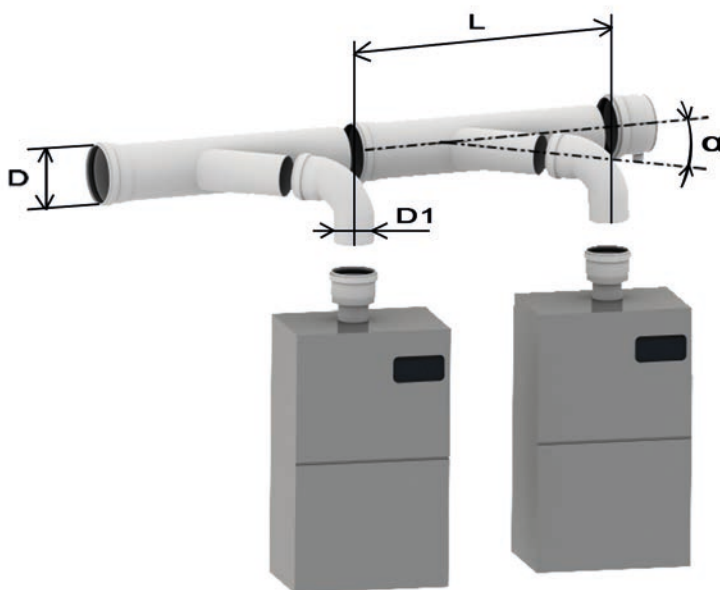

α	D1 (mm)	D [mm]	200
45°	160	kód	KAS P642HN3
		L (mm)	440
		€/Kč	281,30/7609

* cena na vyžiadanie

PPs

komponenty | components | komponente | alkotó elemek
 biela | white | weiss | fehér színben

EN 14 471-T120-P1-O-W-1-O10-I-E-L



Komponenty dymovodov pre kondenzačnú techniku – PPs - teplotná trieda T120

KASKÁDY | KASKÁDY | CASCADES | KASKADEN | KASZKÁD BEKÖTÉS

DVOJKOTLOVÁ SO SPÄTNÝMI KLAPKAMI A UHLOM A=45° | FOR TWO GAS BOILERS (CHECK VALVES INCLUDED)

PPs - T120

α	D1 (mm)	D [mm]	110	125	160	200	110	125	160	200
45°	80	kód	KAS P642BGkl3	KAS P642BDkl3	KAS P642BHkl3	KAS P642BNkl3	KAS P652BGkl3	KAS P652BDkl3	KAS P652BHkl3	KAS P652BNkl3
		L (mm)	440	440	440	440	940	940	940	940
		€/Kč	*	291,00/7872	347,00/9387	365,00/9874	271,00/7331	292,00/7899	321,00/8683	365,00/9874

* cena na vyžiadanie

α	D1 (mm)	D [mm]	110	125	160	200	110	125	160	200
45°	100	kód	KAS P642CGkl3	KAS P642CDkl3	KAS P642CHkl3	KAS P642CNkl3	KAS P652CGkl3	KAS P652CDkl3	KAS P652CHkl3	KAS P652CNkl3
		L (mm)	440	440	440	440	940	940	940	940
		€/Kč	*	291,00/7872	*	389,00/10524	271,00/7331	292,00/7899	321,00/8683	365,00/9874

* cena na vyžiadanie

α	D1 (mm)	D [mm]	110	125	160	200	110	125	160	200
45°	110	kód	KAS P642GGkl3	KAS P642GDkl3	KAS P642GHkl3	KAS P642GNkl3	KAS P652GGkl3	KAS P652GDkl3	KAS P652GHkl3	KAS P652GNkl3
		L (mm)	440	440	440	440	940	940	940	940
		€/Kč	*	*	341,00/9224	*	271,00/7331	292,00/7899	321,00/8683	365,00/9874

* cena na vyžiadanie

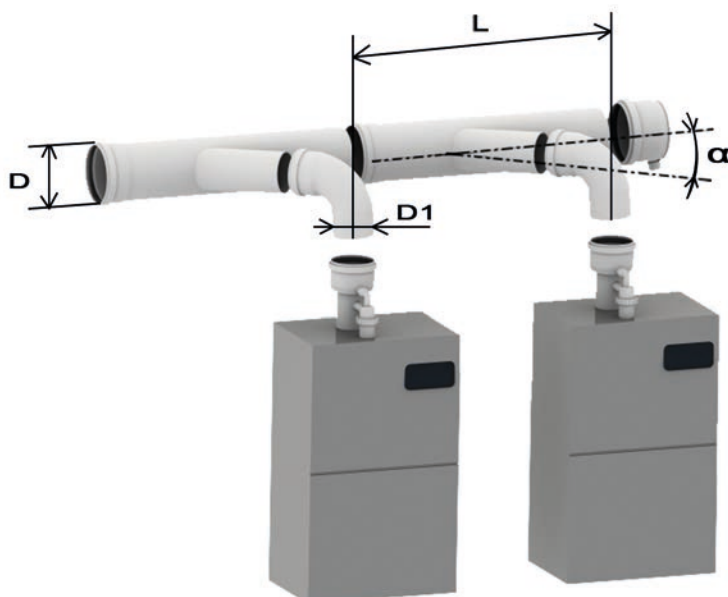

PPs

komponenty | components | komponente | alkotó elemek
 biela | white | weiss | fehér színben
 EN 14 471-T120-P1-O-W-1-O10-I-E-L



Komponenty dymovodov pre kondenzačnú techniku – PPs - teplotná trieda T120

KASKÁDY | KASKÁDY | CASCADES | KASKADEN | KASZKÁD BEKÖTÉS

TROJKOTLOVÁ BEZ SPÄTNÝCH KLAPIEK A UHLOM A=45° | FOR THREE GAS BOILERS (CHECK VALVES NOT INCLUDED)

α	D [mm]	110	125	160	200	110	125	160	200
45°	kód	KAS P653BG3	KAS P653BD3	KAS P653BH3	KAS P653BN3	KAS P653CG3	KAS P653CD3	KAS P653CH3	KAS P653CN3
	D1 (mm)	80	80	80	80	100	100	100	100
	L (mm)	940	940	940	940	940	940	940	940
	€/Kč	175,00/4734	202,00/5465	241,00/6520	293,00/7926	175,00/4734	202,00/5465	241,00/6520	293,00/7926

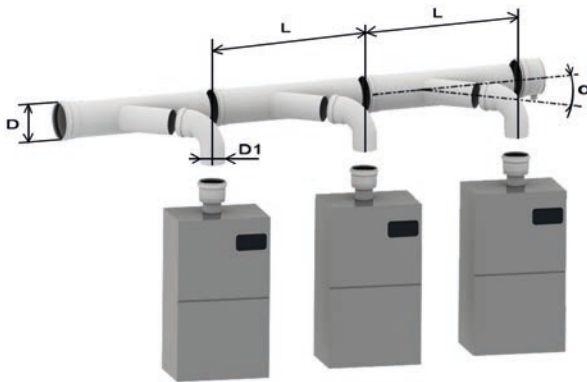

α	D [mm]	125	160	200	250
45°	kód	KAS P653GD3	KAS P653GH3	KAS P653GN3	KAS P643HQ3
	D1 (mm)	110	110	110	160
	L (mm)	940	940	940	440
	€/Kč	202,00/5465	241,00/6519	293,00/7925	445,40/12048

TROJKOTLOVÁ SO SPÄTNÝMI KLA PKAMI A UHLOM A=45° | FOR THREE GAS BOILERS (CHECK VALVES INCLUDED)

α	D [mm]	110	125	160	200	110	125	160	200
45°	kód	KAS P653BGk3	KAS P653BDk3	KAS P653BHk3	KAS P653BNk3	KAS P653CGk3	KAS P653CDk3	KAS P653CHk3	KAS P653CNk3
	D1 (mm)	80	80	80	80	100	100	100	100
	L (mm)	940	940	940	940	940	940	940	940
	€/Kč	395,00/10685	421,00/11388	460,00/12443	505,00/13660	395,00/10685	421,00/11389	460,00/12443	505,00/13660

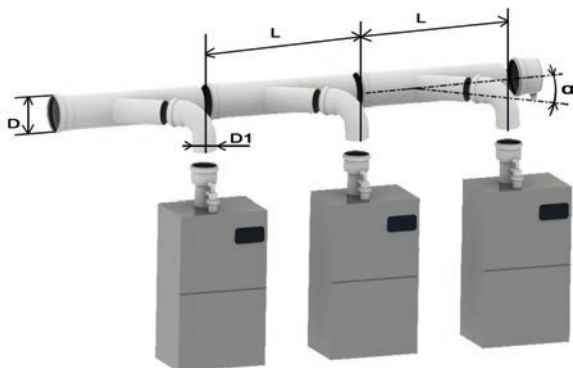

α	D [mm]	125	160	200
45°	kód	KAS P653GDk3	KAS P653GHk3	KAS P653GNk3
	D1 (mm)	110	110	110
	L (mm)	940	940	940
	€/Kč	421,00/11388	460,00/12443	505,00/13660

α	D [mm]	160	160
45°	kód	KAS P643GHk3	KAS P643GNk3
	D1 (mm)	110	110
	L (mm)	440	440
	€/Kč	492,00/13309	506,00/13687

PPs

komponenty | components | komponente | alkotó elemek
 biela | white | weiss | fehér színben

EN 14 471-T120-P1-O-W-1-O10-I-E-L



Komponenty dymovodov pre kondenzačnú techniku – PPs - teplotná trieda T120

PPs - T120

KONZOLA | KONZOLA | PLATE SUPPORT | KONSOLE | KONZOL

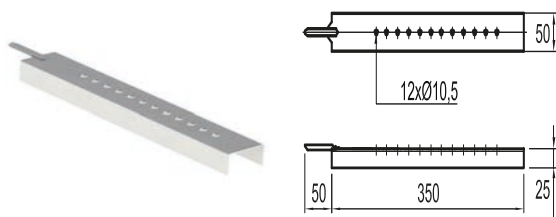

kód	840KZ
€/Kč	7,00/189

KOTVIACA OBJÍMKA | KOTVÍCÍ OBJÍMKA | FIXATION SLEEVE | HALTEKLAMMER | RÖGZÍTŐ BILINCS

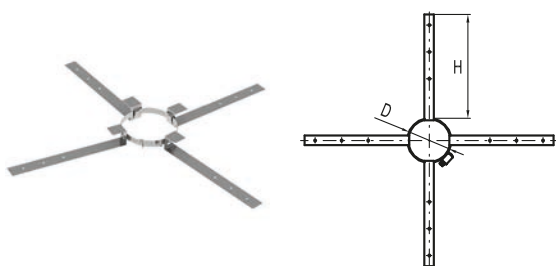

D [mm]	80	100	150
kód	901BC	901CC	901MK
H (mm)	190	190	190
€/Kč	3,50/94	5,00/138	7,00/189

DIŠTANČNÁ OBJÍMKA | DISTANČNÍ OBJÍMKA | DISTANCE SLEEVE | KÖZPONTOSÍTÓ BILINCS



D [mm]	50-200
kód	P901UC
D1 (mm)	≈ 300 - 450
€/Kč	14,00/379
<i>balené po 4 ks</i>	



D [mm]	80-125
kód	P902BC
€/Kč	3,30/89

TESZENIE | TĚSNĚNÍ | GASKET | DICHTUNG | TÖMÍTŐ GYŰRŰ



D [mm]	60	80	100	110	125	160	200
kód	811AG	811BG	811CG	811GG	811DG	811HG	811NG
materiál	EPDM	EPDM	EPDM	EPDM	EPDM	EPDM	EPDM
€/Kč	1,00/28	1,30/35	2,50/68	2,70/71	3,00/83	4,00/104	5,00/130

PPs

komponenty | components | komponente | alkotó elemek
 biela | white | weiss | fehér színben
 EN 14 471-T120-P1-O-W-1-O10-I-E-L



Komponenty dymovodov pre kondenzačnú techniku – PPs - teplotná trieda T120

SPÄTNÁ KLAPKA + SIFÓN | ZPĚTNÁ KLAPKA + SIFON | CHECK VALVE WITH SIPHON
 RÜCKLAUFKLAPPE MIT SIPHON | VISSZAÁRAMLÁST GÁTLO SZELEP SZIFONNAL

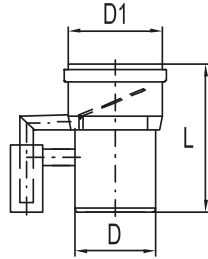

D [mm]	80	80	100	110
kód	P517BCNK	P517BGNK	P517CGNK	P517GNK
D1 (mm)	100	110	110	110
L (mm)	180	180	180	180
€/Kč	80,00/2165	80,00/2165	80,00/2165	80,00/2165



D [mm]	80
kód	P217Bkl
€/Kč	55,00/1488

PPs - T120

SIFÓNÝ | SIFONY | SIPHON | SIPHON | KONDENZVIZES SZIFON



PA832SIFr

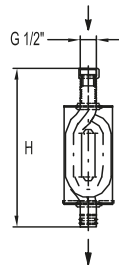

832SIF

kód	PA832SIFr
H (mm)	210
€/Kč	12,00/330
kód	832SIF
€/Kč	19,50/528

HADICA NA ODVOD KONDENZÁTU | HADICE NA ODVOD KONDENZÁTU | HOSE FOR CONDENSATION DRAIN
 KONDENSATAUSLAUF | KONDENZÁTUM ELVEZETŐ CSŐ

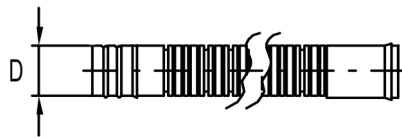

D [mm]	1/2"
kód	P832F
€/Kč	2,20/59
cena za 1 m (price for 1 meter)	

NADSTAVEC | NÁSTAVEC | EXTENSION | ERWEITERUNG | TOLDÓ IDOMOK

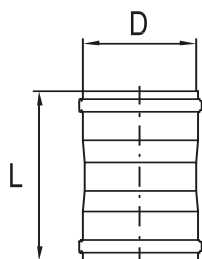

D [mm]	60	80	100
kód	P515AM	P513BM	P515CM
L (mm)	150	130	150
€/Kč	6,80/184	8,20/222	17,90/482



Komponenty dymovodov pre kondenzačnú techniku – PPs - teplotná trieda T120

PPs - T120

KOŠÍKY | KOŠÍKY | SUCTION/ANTI-INTRUSION GRID | GITTER | KOSARAK

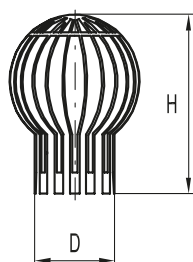

materiál: PPs

D [mm]	80-100
kód	P890U
H (mm)	170
€/Kč	3,50/94

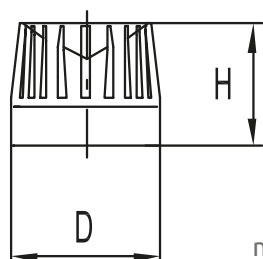

materiál: PPs

D [mm]	80
kód	P890BH
H (mm)	70
€/Kč	5,50/148

KOŠÍKY | KOŠÍKY | SUCTION/ANTI-INTRUSION GRID | GITTER | KOSARAK

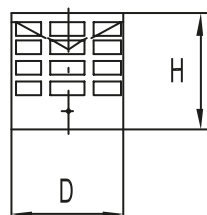

materiál: INOX

D [mm]	60	80	100	125
kód	N890AH	N890BH	N890CH	N890DH
H (mm)	75	80	80	80
€/Kč	7,00/190	7,30/197	11,10/300	21,30/576

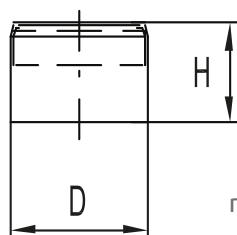

materiál: AL

D [mm]	80	100	110	125
kód	A890BH	A890CH	A890GH	A890DH
H (mm)	60	60	60	60
€/Kč	4,50/122	10,30/268	12,30/320	14,80/385

MONTÁŽNE TIAHLO NA FLEXIBILNÚ RÚRU | MONTÁŽNÍ TÁHLO NA FLEXIBILNÍ TRUBKU | MOUNTING ROD FOR FLEXIBLE PIPE
MONTAGEANHANG FÜR DAS FLEXIROHR | FLEXIBILIS CSŐ HÚZÓ FEJ



D [mm]	80
kód	820NT
€/Kč	7,50/202

PPs/Al

komponenty | components | komponente | alkotó elemek
 biela | white | weiss | fehér színben

EN 14 471-T120-P1-O-W-1-O00-E-E-L0



Komponenty koncentrických dymovodov pre kondenzačnú techniku - vložka PPS/AL - teplotná trieda T120

RÚRA | TRUBKA | STRAIGHT ELEMENT | ROHR | CSŐ

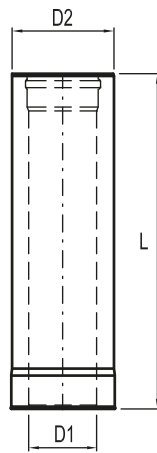
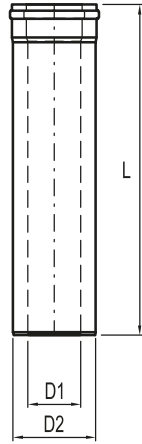

L [mm]	D1/D2 [mm]	60/100	80/125
250	kód	PA002T	PA002E
	€/Kč	9,00/243	14,00/378
500	kód	PA005T	PA005E
	€/Kč	15,00/406	19,50/527
1000	kód	PA010T	PA010E
	€/Kč	18,00/487	26,00/704
2000	kód	PA020T	PA020E
	€/Kč	36,00/974	52,00/1407

L [mm]	100/150	110/160
500	PA005MC	PA005HG
	27,70/749	36,90/998
1000	PA010MC	PA010HG
	38,00/1028	57,00/1542

PPS/AL - T120

RÚRA S REVÍZNÝM OTVOROM | TRUBKA S REVÍZNÍM OTVOREM | INSPECTION ELEMENT
 KONTROLLROHR | EGYENES ELLENŐRZŐ IDOM

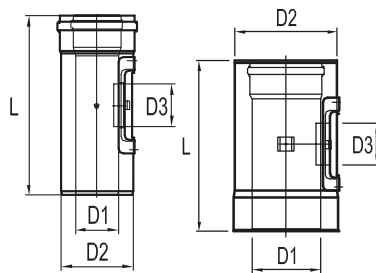

PA002TD
PA002ED

PA002MCD
PA002GHD

L [mm]	D3 [mm]	D1/D2 [mm]	60/100	80/125
250	57	kód	PA002TD	PA002ED
		€/Kč	30,00/811	40,00/1082

L [mm]	D3 [mm]	D1/D2 [mm]	100/150	110/160
250	57	kód	PA002MCD	PA002GHD
		€/Kč	49,00/1325	*

* cena na vyžiadanie

KOLENÁ | KOLENÁ | ELBOW | BOGEN | KÖNYÖKÖK

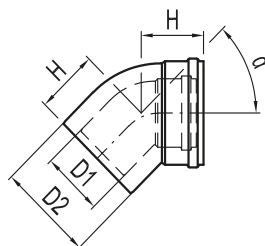

α	D1/D2 [mm]	60/100	80/125
45°	kód	PA045TO	PA045EO
	H (mm)	80	80
	€/Kč	16,00/432	22,00/595

PPs/Al

komponenty | components | komponente | alkotó elemek
 biela | white | weiss | fehér színben

EN 14 471-T120-P1-O-W-1-O00-E-E-L0



Komponenty koncentrických dymovodov pre kondenzačnú techniku - vložka PPS/AL - teplotná trieda T120

KOLENÁ | KOLENÁ | ELBOW | BOGEN | KÖNYÖKÖK

PPs/Al - T120

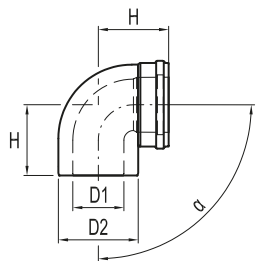

D1/D2 [mm]	60/100	80/125
kód	PA093TO	PA093EO
H (mm)	80	80
α	93°	90°
€/Kč	16,00/432	22,00/595

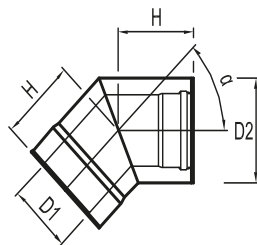

α	D1/D2 [mm]	100/150	110/160
45°	kód	PA045MCO	PA045HGO
	H (mm)	120	140
	€/Kč	46,00/1244	54,00/1461

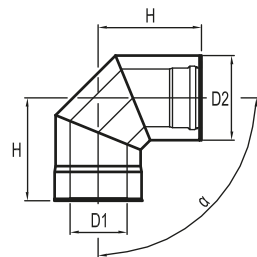

α	D1/D2 [mm]	100/150	110/160
90°	kód	PA090MCO	PA090HGO
	H (mm)	165	210
	€/Kč	46,00/1245	57,00/1542

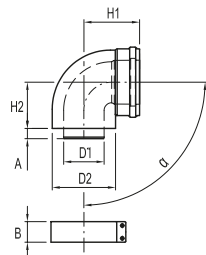

D1/D2 [mm]	60/100	80/125
kód	PA093TOS	PA093EOS
H1 (mm)		110
H2 (mm)		95
A (mm)	15	15
B (mm)	40	40
α	93°	90°
€/Kč	21,00/568	27,00/731

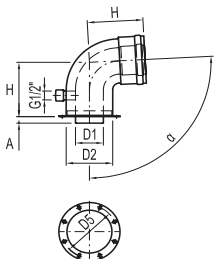

D1/D2 [mm]	60/100	60/100	80/125
kód	PA093TPO	PA093TPO2	PA093EPO
H (mm)	120	120	110
D5 (mm)	112÷124	112÷124	154
A (mm)	15	25	20
α	93°	93°	90°
€/Kč	25,00/677	27,00/730	37,00/1001

PPs/Al

komponenty | components | komponente | alkotó elemek
 biela | white | weiss | fehér színben
 EN 14 471-T120-P1-O-W-1-O00-E-E-L0



Komponenty koncentrických dymovodov pre kondenzačnú techniku - vložka PPs/AL - teplotná trieda T120

KOLENÁ S REVÍZNYM OTVOROM | KOLENÁ S REVIZNÍM OTVOREM | ELBOW WITH INSPECTION
 KONTROLLBOGEN | ELLENŐRZŐ KÖNYÖKÖK

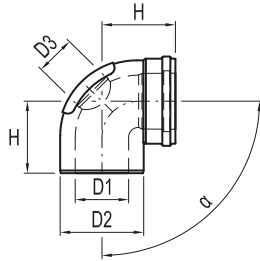

D1/D2 [mm]	60/100	80/125	100/150	110/160
kód	PA093TD	PA093ED	PA090MCD	PA090GHD
H (mm)	120	110		
D3 (mm)	57	57		
α	93°	93°	90°	90°
€/Kč	35,00/948	45,00/1217	*	*

* cena na vyžiadanie

PPs/Al - T120

T-KUS | T-KUS | T-PIECE | T-STÜCK | T-IDOMOK

T-KUS | T-KUS | T-PIECE | T-STÜCK | T-IDOMOK

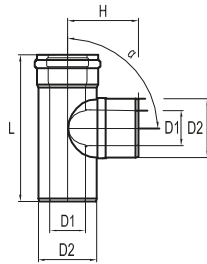

L [mm]	α	D1/D2 [mm]	60/100	80/120
250	90°	kód	PA421TT	PA421ET
		H (mm)	120	110
		€/Kč	22,00/595	29,00/784

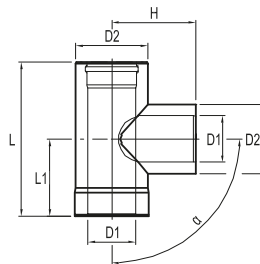

L [mm]	α	D1/D2 [mm]	100/150	110/160
330	90°	kód	PA421MCT	PA421GHT
		H (mm)	175	-
		€/Kč	*	*

* cena na vyžiadanie

T-KUS S UZÁVEROM | T-KUS S UZÁVĚREM | T-PIECE WITH DRAIN CAP
 T-STÜCK MIT KONDENSATABLAUF | T-IDOMOK KONDENZÁTUM GYÚJTÓ EDÉNYEL

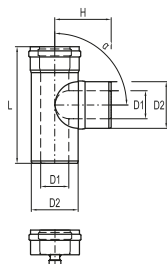

α	D1/D2 [mm]	60/100	80/125
90°	kód	PA409TK	PA409EK
	L (mm)	250	250
	H (mm)	120	110
	€/Kč	35,00/948	42,00/1136

PPs/Al

komponenty | components | komponente | alkotó elemek
 biela | white | weiss | fehér színben

EN 14 471-T120-P1-O-W-1-000-E-E-L0



Komponenty koncentrických dymovodov pre kondenzačnú techniku - vložka PPS/AL - teplotná trieda T120

T-KUS S UZÁVEROM | T-KUS S UZÁVĚREM | T-PIECE WITH DRAIN CAP
 T-STÜCK MIT KONDENSATBLAUF | T-IDOMOK KONDENZÁTUM GYÚJTÓ EDÉNYEL

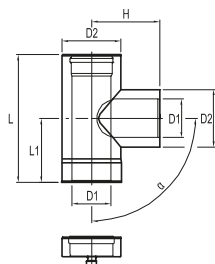

α	D1/D2 [mm]	100/150	110/160
90°	kód	PA409MCK	PA409GHK
	L (mm)	330	330
	H (mm)	175	183
	€/Kč	75,00/2029	*

+++

PPs/Al - T120

KONDEZAČNÝ UZÁVER | KONDEZAČNÍ UZÁVĚR | CONDENSATION DRAIN
 KONDENSATFALLE | KONDENZÁTUM LEVÁLASZTÓ | GYÚJTÓ EDÉNY

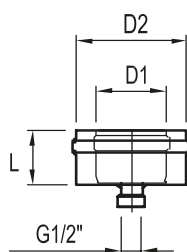

D1/D2 [mm]	60/100	80/125
kód	PA452TN	PA452EN
L (mm)	55	55
€/Kč	13,00/352	13,00/352

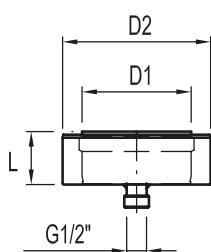

D1/D2 [mm]	100/150	110/160
kód	PA452MCN	PA452GHN
L (mm)	53	-
€/Kč	17,00/460	*

* cena na vyžiadanie

ZACHYTÁVAČ KONDENZÁTU | ZACHYTÁVAČ KONDENZÁTU | CONDENSATE SEPARATOR
 KONDENSATSAMMLER | KONDENZÁTUM LEVÁLASZTÓ

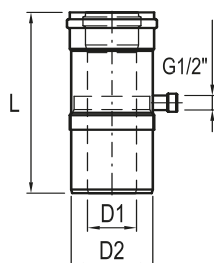

D1/D2 [mm]	60/100	80/125
kód	PA417TCN	PA417EDN
L (mm)	170	250
€/Kč	25,00/677	32,00/866

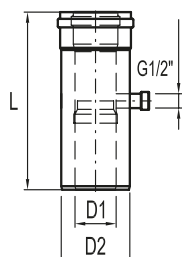

D1/D2 [mm]	60/100	80/125
kód	PA417TN	PA417EN
L (mm)	170	250
€/Kč	25,00/677	32,00/866

PPs/Al

komponenty | components | komponente | alkotó elemek
 biela | white | weiss | fehér színben

EN 14 471-T120-P1-O-W-1-O00-E-E-L0



Komponenty koncentrických dymovodov pre kondenzačnú techniku - vložka PPS/AL - teplotná trieda T120

ZACHYTÁVAČ KONDENZÁTU | ZACHYTÁVAČ KONDENZÁTU | CONDENSATE SEPARATOR
 KONDENSATSAMMLER | KONDENZÁTUM LEVÁLASZTÓ

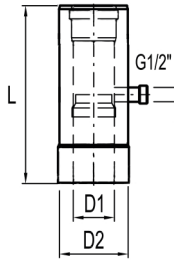
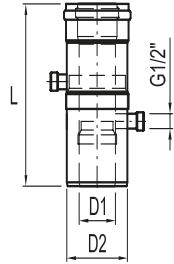

D1/D2 [mm]	60/100	80/125
kód	PA417TN2	PA417EN2
L (mm)	200	250
€/Kč	39,00/1056	39,00/1056

D1/D2 [mm]	100/150	110/160
kód	PA417MCN	PA417GHN
L (mm)	200	250
€/Kč	39,00/1056	46,00/1245

PPS/Al - T120

REDUKCIE | REDUKCE | REDUCER | REDUKTION | BŐVÍTŐK

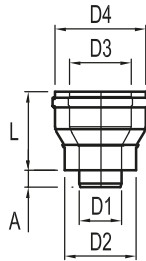

D1/D2 [mm]	60/100	60/100	80/125
kód	PA426TR	PA426TRR	PA426ER
L (mm)	120	120	120
D3 (mm)	80	80	100
D4 (mm)	125	125	150**
A	45	0	0
€/Kč	18,50/501	18,50/501	*

* cena na vyžiadanie
 ** bez tesnenia

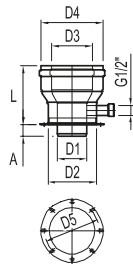

D1/D2 [mm]	60/100	80/125
kód	PA426TRP	PA426ERP
L (mm)	125	-
D3 (mm)	80	100
D4 (mm)	125	150**
D5 (mm)	112÷124	-
A	35	-
€/Kč	24,00/649	*

* cena na vyžiadanie
 ** bez tesnenia

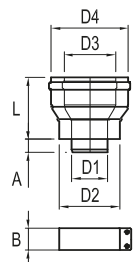

D1/D2 [mm]	60/100
kód	PA426TRS
L (mm)	120
D3 (mm)	80
D4 (mm)	125
A	15
B	40
€/Kč	22,50/609

PPs/Al

komponenty | components | komponente | alkotó elemek
 biela | white | weiss | fehér színben

EN 14 471-T120-P1-O-W-1-O00-E-E-L0



Komponenty koncentrických dymovodov pre kondenzačnú techniku - vložka PPS/AL - teplotná trieda T120

ROZDELOVAČE | ROZDĚLOVAČE | SPLITTER | VERTEILER | OSZTÓ IDOMOK

PPs/Al - T120

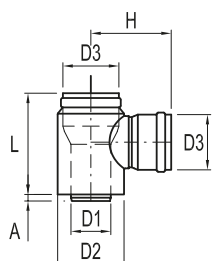

D1/D2 [mm]	60/100	80/125
kód	PA422TTO	PA422ET
L (mm)	165	185
H (mm)	120	135
D3 (mm)	80	80
A	10	20
€/Kč	17,50/473	24,00/649

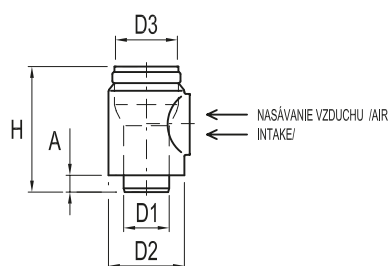

D1/D2 [mm]	60/100	80/125
kód	PA422TB	PA422EB
H (mm)	185	180
D3 (mm)	80	80
A	22	22
€/Kč	17,50/473	24,00/649

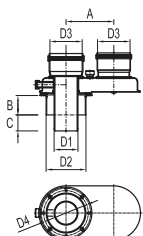

D1/D2 [mm]	60/100
D3 [mm]	80
kód	PA422TBL2
A (mm)	120
B (mm)	50
C (mm)	40
€/Kč	35,50/961

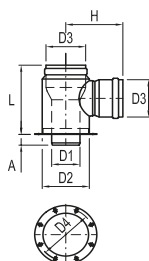

D1/D2 [mm]	60/100
kód	PA422TPN
L (mm)	170
H (mm)	125
D3 (mm)	80
D4 (mm)	112÷124
A	12
€/Kč	21,00/568

PPs/Al

komponenty | components | komponente | alkotó elemek
 biela | white | weiss | fehér színben

EN 14 471-T120-P1-O-W-1-O00-E-E-LO



komponenty koncentrických dymovodov pre kondenzačnú techniku - vložka PPS/AL - teplotná trieda T120

PRÍRUBY | PŘÍRUBY | FLANGES | FLANSCH | CSATLAKOZÓ KARIMÁK

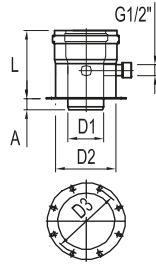

kód	PA430TP	PA430TPO	PA445TPO
L (mm)	115	115	115
D1 (mm)	60	60	60
D2 (mm)	100	100	100
D3 (mm)	112÷124	112÷124	112÷124
A (mm)	20	30	45
€/Kč	21,00/568	21,00/568	22,00/595

PPS/Al - T120

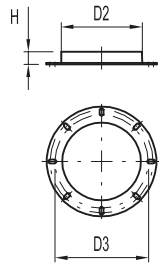

kód	441CP
D1 (mm)	100
D2 (mm)	97
D3 (mm)	112÷124
H (mm)	15
€/Kč	4,00/108

KOMÍNY | KOMÍNY | CHIMNEYS | KAMINE | KÉMENYEK

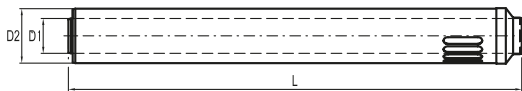

D1/D2 [mm]	60/100	60/100
kód	PA007TH	PA012TH
L (mm)	750	1000
€/Kč	19,00/515	21,00/569

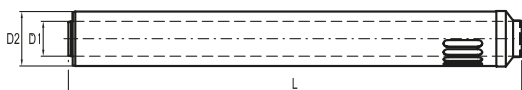

D1/D2 [mm]	80/125	80/125
kód	PA007EH	PA012EH/1
L (mm)	700	1050
€/Kč	25,00/676	25,00/676

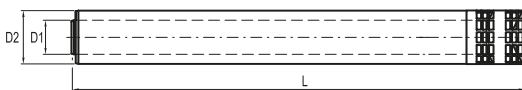

D1/D2 [mm]	60/100	80/125
kód	PA011TH	PA011EH
L (mm)	1000	1100
€/Kč	27,00/730	30,00/810

PPs/Al

komponenty | components | komponente | alkotó elemek
 biela | white | weiss | fehér színben

EN 14 471-T120-P1-O-W-1-O00-E-E-L0



Komponenty koncentrických dymovodov pre kondenzačnú techniku - vložka PPS/AL - teplotná trieda T120

KOMÍNY | KOMÍNY | CHIMNEYS | KAMINE | KÉMENYEK

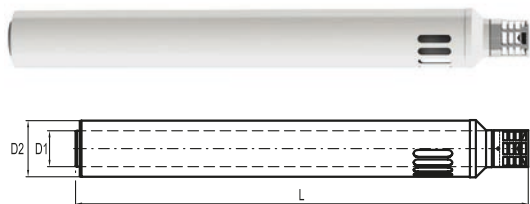

D1/D2 [mm]	80/125
kód	PA012EH
L (mm)	1130
€/Kč	28,00/758

PPs/Al - T120

STREŠNÉ KOMÍNY | STŘEŠNÍ KOMÍNY | ROOF MOUNTED CHIMNEYS | DACHTEILE | TETŐÁTVÉZETESÉK

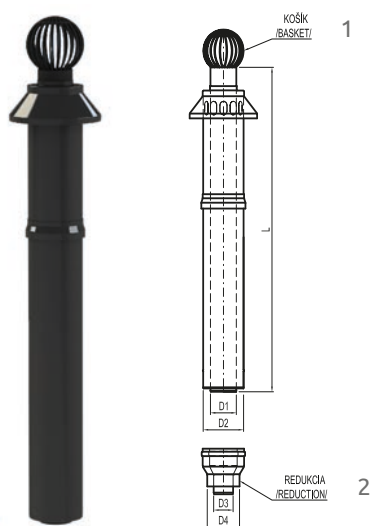

D1/D2 [mm]	60/100	80/125	80/125
kód	PA012TSL	PA011ESL	PA011ESR
L (mm)	1040	1160	1160
D3 (mm)	-	-	60
D4 (mm)	-	-	100
1	-	✓	✓
2	-	-	✓
€/Kč	50,00/1353	49,00/1326	62,00/1678

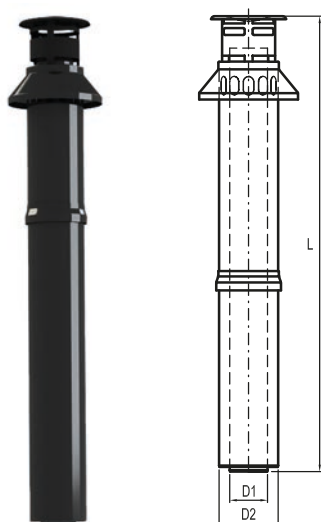

D1/D2 [mm]	60/100	80/125
kód	PA011TSL	PA012ESL
L (mm)	1100	1100
€/Kč	49,00/1326	55,00/1488

PPs/Al

komponenty | components | komponente | alkotó elemek
 biela | white | weiss | fehér színben
 EN 14 471-T120-P1-O-W-1-O00-E-E-L0



Komponenty koncentrických dymovodov pre kondenzačnú techniku - vložka PPS/AL - teplotná trieda T120

KOMÍNOVÉ HLAVICE | KOMÍNOVÉ HLAVICE | FLUE TERMINATIONS | KAMINHAUBE | KÉMÉNY FEJ

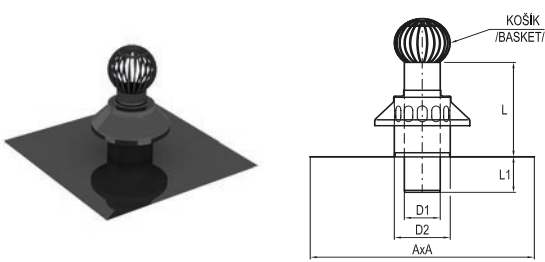

D1/D2 [mm]	60/100	80/125	100/150	110/160	125/200
kód	P417ASK	P417BSK	P417CSK	P417GSK	P417DSK
L (mm)	310	310	310	310	290
L1 (mm)	90	90	90	90	90
A (mm)	500	500	500	500	500
1	✓	✓	✓	✓	-
€/Kč	28,00/757	28,00/758	45,00/1028	48,00/1298	54,00/1461

PPs/Al - T120

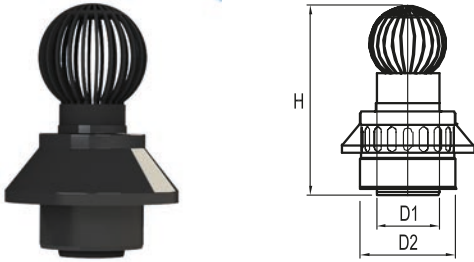

D1/D2 [mm]	60/100	80/125	100/150	110/160
kód	PA416TAV	PA417EBV	PA418MCV	PA417GHV
H (mm)	245	295	310	320
€/Kč	25,00/688	26,00/703	34,10/920	50/1300

KRYT KOMÍNA | KRYTÍ KOMÍNA | WALL PLATE | KAMINDECKPLATTE | TAKARÓLEMEZ

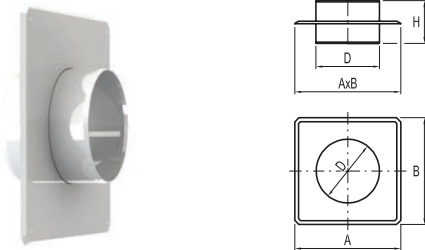

D [mm]	100	125	130	150
kód *	A841CL	A841DL	A841FL	A841ML
H (mm)	100	100	100	100
AxB (mm)	250x250	250x250	250x250	250x250
€/Kč	9,00/244	9,50/256	10,10/271	10,50/285

* ZMENA KÓDU

KRYCIA MANŽETA | KRYCÍ MANŽETA | WALL COVER ROSE | DECKUNGSMANSCHETTE | TAKARÓ MANDZSETTA

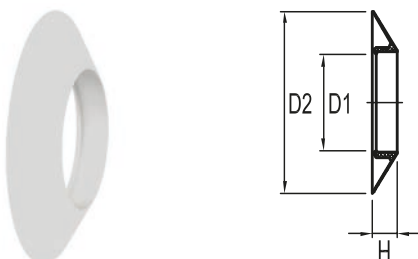

D1 [mm]	100	125
kód	G830C	G830D
D2 (mm)	163	225
H (mm)	18	32
€/Kč	3,00/82	4,00/109

PPs/Al

komponenty | components | komponente | alkotó elemek
 biela | white | weiss | fehér színben

EN 14 471-T120-P1-O-W-1-000-E-E-L0



Protidažový golier | Protidešťový límec | Rain collar | Wetterschutzkragen | Esővédő gallér

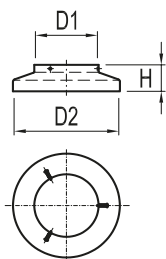

D1 [mm]	80	100	125
kód	412BY	412CY	412DY
D2 (mm)	135	135	135
H (mm)	35	60	42
€/Kč	10,00/270	10,00/270	11,00/298

PPs/Al - T120

Košíky | Košíky | Suction/Anti-intrusion grid | Gitter | Kosarak

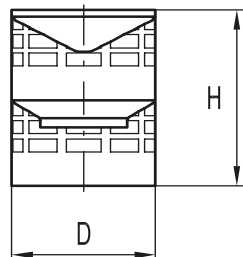

D1 [mm]	60	80
kód	N890TH	N890EH
D2 (mm)	100	125
H (mm)	140	135
€/Kč	14,50/392	23,90/647

Strešná prechodka | Přejchodka střešní | Flashing | Durchgangskragen | Tető borítás

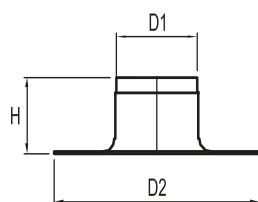
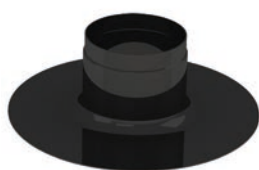

D1 [mm]	130
kód	801PS
D2 (mm)	335
H (mm)	110
€/Kč	16,00/432

Strešná prechodka-šikmá | Přejchodka střešní-šikmá | Flashing for inclined roofs | Schrägdachpfanne | Ferdetető borítás

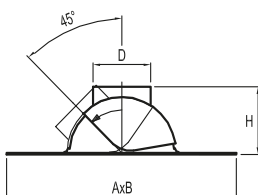
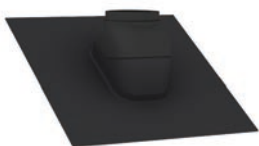

D [mm]	125
kód	810PS
H (mm)	135
AxB (mm)	500x500
€/Kč	29,00/786

Hadica na odvod kondenzátu | Hadice na odvod kondenzátu | Hose for condensation drain | Kondensatauslauf | Kondenzátum elvezető cső

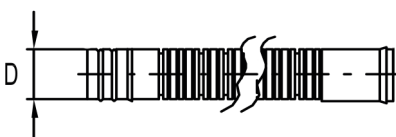

D [mm]	1/2"
kód	P832F
€/Kč	2,20/59
cena za 1 m (price for 1 meter)	

PPs/Al

komponenty | components | komponente | alkotó elemek
 biela | white | weiss | fehér színben
 EN 14 471-T120-P1-O-W-1-O00-E-E-LO



Componenty koncentrických dymovodov pre kondenzačnú techniku - vložka PPS/AL - teplotná trieda T120

MAZACIA PASTA | MAZACÍ PASTA | LUBRICANT PASTE | LUBRIKANT | KENŐZSÍR



kód	833SIP
Objem (ml)	150
€/Kč	4,40/119

OBJÍMKA | OBJÍMKA | SLEEVE | MANSCHETTE | BILINCS

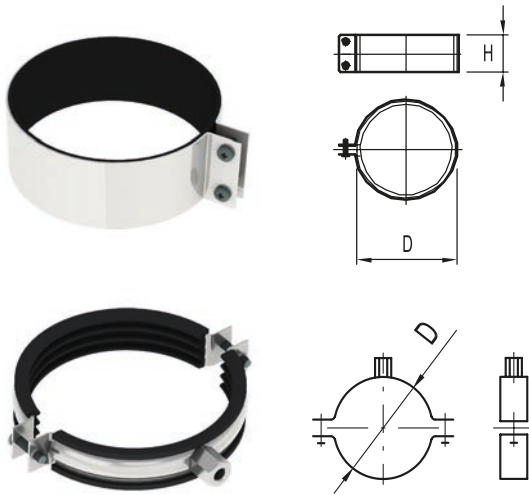

D [mm]	60	80	100	125
kód	425AO	425BO	425CO	425DO
H (mm)	40	40	40	40
€/Kč	4/108	4/108	4,00/108	4,00/108

D [mm]	110	125	160	200
kód	902G	902D	902M	902U
H (mm)	40	40	40	40
€/Kč	5,60/146	7,00/189	8,00/216	12/312

SIFÓNÝ | SIFONY | SIPHONS | SIPHON | SZIFONOK



PA832SIFr

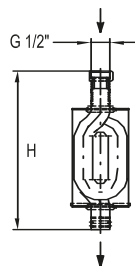

832SIF

kód	PA832SIFr
H (mm)	210
€/Kč	12,00/330

kód	832SIF
€/Kč	19,50/528

STREDIACE PRVKY | STŘEDÍCÍ PRVEK | CENTRING BAND | ABSTANDHALTER | KÖZPONTOSÍTÓ ELEMÉK



D1 [mm]	60		80	
kód	P861TLa	P861TLb	P881TLa	P881TLb
D2 (mm)	100		125	
€/Kč	1,80/47		3,20/83	

IZOLOVANÉ KOMPONENTY | ISOLATED COMPONENTS

ABGASKOMPONENTE GEDÄMMT | SZIGETELT FÜSTGÁZELVEZETŐ RENDSZER

RÚRA IZOLOVANÁ | TRUBKA IZOLOVANÁ | INSULATED PIPE | ROHR GEDÄMMT | SZIGETELT CSŐ

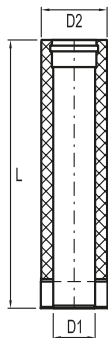

L [mm]	D1/D2 [mm]	80/1125	100/150	110/160
1000	kód	P110BI	P110CI	P110GI
	€/Kč	27,50/743	42,70/1155	50,00/1353

PPs/Al - T120

KOLENO IZOLOVANÉ | KOEENO IZOLOVANÉ | INSULATED ELBOW | BOGEN GEDÄMMT | SZIGETELT KÖNYÖKÖK

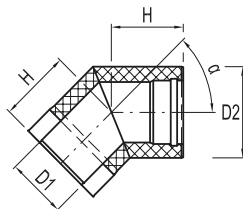

α	D1/D2 [mm]	80/125	100/150	110/160
45°	kód	P145BI	P145CI	P145GI
	H (mm)	80	120	140
	€/Kč	25,50/688	25,90/700	25,90/700

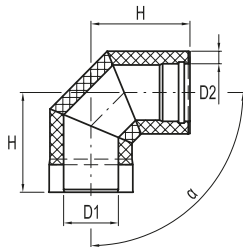

D1/D2 [mm]	80/125	100/150	110/160
kód	P190BI	P190CI	P190GI
H (mm)	110	170	210
α	90°	93°	90°
€/Kč	25,50/688	33,30/900	33,30/900

T-KUS S UZÁVEROM, IZOLOVANÝ | T-KUS IZOLOVANÝ S UZÁVĚREM | INSULATED T-PIECE WITH DRAIN CAP

T-STÜCK MIT KONDENSATABLAUF GEDÄMMT | SZIGETELT T-IDOMOK KONDENZÁTUM GYŰJTŐ EDÉNYEL

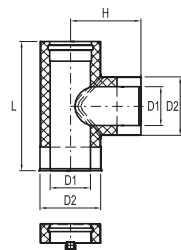

D1/D2 [mm]	80/125	80/125	100/150	100/150	110/160	110/160
kód	P509BKI	P509BKIM	P509CKI	P509CKIM	P509GKI	P509GKIM
L (mm)	250	250	330	330	440	440
H (mm)	110	110	170	170	180	180
€/Kč	45,80/1238	47,00/1271	76,00/2056	78,00/2110	70,30/1900	94,00/2543

KOMÍNOVÉ HLAVICE | KOMÍNOVÉ HLAVICE | FLUE TERMINATIONS | KAMINHAUBE | KÉMÉNY FEJ

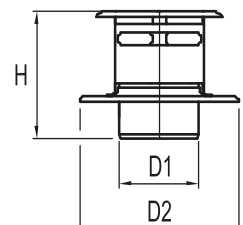

D1/D2 [mm]	80/185	100/200	110/230	125/180
kód	517BSI	518CSI	519GSI	520DSI
H (mm)	150	150	150	150
€/Kč	20,00/541	20,00/541	29,00/785	30/780

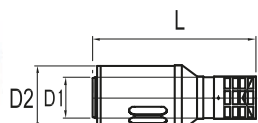

D1/D2 [mm]	80/125	100/150
kód	PA555EBH	PA555MCH
H (mm)	310	310
€/Kč	27,00/731	35,00/963

Al

hliníkové komponenty | aluminium components | aluminium komponente | aluminium alkotó elemek
 RAL 9003 - biela | white | weiss | fehér színben
 EN 1856-T200-P1-D-V1-L13150-O70



Komponenty dymovodov - Al - teplotná trieda T200

RÚRA | TRUBKA | STRAIGHT ELEMENT | ROHR | CSŐ

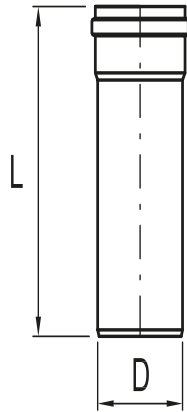

L [mm]	D [mm]	60	80	100	125
250	kód	002A	002B	002C	002D
	€/Kč	4,50/122	5,00/136	7,00/190	10,30/278
500	kód	005A	005B	005C	005D
	€/Kč	5,80/157	6,20/167	10,50/284	13,50/365
1000	kód	010A	010B	010C	010D
	€/Kč	9,30/251	10,50/284	17,00/461	18,00/487
2000	kód	020A	020B	020C	020D
	€/Kč	17,50/473	20,00/541	30,00/812	40,00/1081

RÚRA S REVÍZNYM OTVOROM | TRUBKA S REVÍZNÍM OTVOREM | INSPECTION ELEMENT
 KONTROLLROHR | EGYENES ELLENŐRZŐ IDOM

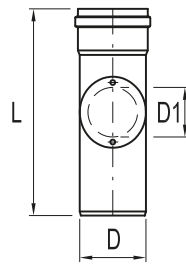

L [mm]	D [mm]	60	80	100	125
250	kód	002AD	002BD	002CD	002DD
	D1 (mm)	45	45	60	60
	€/Kč	15,00/406	17,50/473	19,50/527	23,50/635

KOLENÁ | KOLENÁ | ELBOW | BOGEN | KÖNYÖKÖK

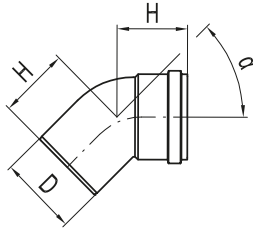

α	D [mm]	60	80	100	125
45°	kód	045AO	045BO	045CO	045DO
	H (mm)	80	70	80	80
	€/Kč	7,80/211	7,00/190	11,00/298	14,50/392

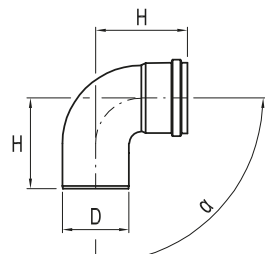

α	D [mm]	60	80	100	125
93°	kód	093AO		093CO	
	H (mm)	120		120	
	€/Kč	7,80/211		11,00/298	
90°	kód		090BO		090DO
	H (mm)		90		110
	€/Kč		7,00/190		14,50/392

Al - T200

Al

hliníkové komponenty | aluminium components | aluminium komponente | alumínium alkotó elemek
 RAL 9003 - biela | white | weiss | fehér színben
 EN 1856-T200-P1-D-V1-L13150-O70



Komponenty dymovodov - Al - teplotná trieda T200

KOLENÁ S REVÍZNYM OTVOROM | KOLENÁ S REVÍZNÍM OTVOREM | ELBOW WITH INSPECTION
 KONTROLLBOGEN | ELLENŐRZŐ KÖNYÖKÖK

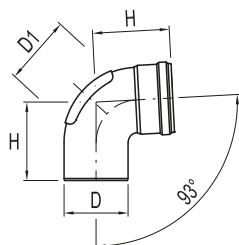

α	D [mm]	60	80	100	125
93°	kód	093AD		093CD	
	H (mm)	120		120	
	D1 (mm)	45		45	
	€/Kč	15,50/419		21,00/569	
90°	kód		091BD		090DD
	H (mm)		110		110
	D1 (mm)		45		45
	€/Kč		18,00/487		24,00/649

Al - T200

KOLENÁ S KONZOLOU | KOLENA S KONZOLOU | CHIMNEY SUPPORT ELBOW | BOGEN MIT STÜTZFUSS | TALPAS KÖNYÖKÖK

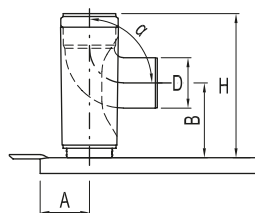

α	D [mm]	80
90°	kód	090BKZ
	H (mm)	230
	A (mm)	80÷300
	B (mm)	120
	€/Kč	25,00/676

T-KUS | T-KUS | T-PIECE | T-STÜCK | T-IDOMOK

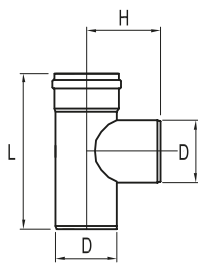

L [mm]	D [mm]	60	80	100	125
250	kód	421AT	421BT	421CT	421DT
	L1 (mm)	125	100	125	100
	H (mm)	120	110	120	110
	€/Kč	16,50/446	14,00/378	17,50/473	25,00/676

T-KUS S UZÁVEROM | T-KUS S UZÁVĚREM | T-PIECE WITH DRAIN CAP
 T-STÜCK MIT KONDENSATABLAUF | T-IDOMOK KONDENZÁTUM GYŰJTŐ EDÉNYEL

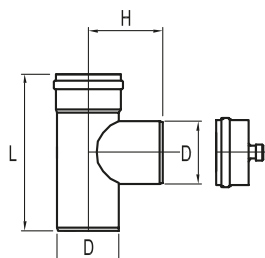

L [mm]	D [mm]	60	80	100	125
250	kód	409AK	409BK	409CK	409DK
	H (mm)	120	110	120	110
	€/Kč	20,20/546	20,20/546	25,00/677	42,30/1143

Al

hliníkové komponenty | aluminium components | aluminium komponente | alumínium alkotó elemek
 RAL 9003 - biela | white | weiss | fehér színben
 EN 1856-T200-P1-D-V1-L13150-O70

**Komponenty dymovodov - Al - teplotná trieda T200**

KONDEZNAČNÝ UZÁVER | KONDEZNAČNÍ UZÁVĚR | CONDENSATION DRAIN CAP
 VERSCHLUSS MIT KONDENSATABLAUF | KONDEZÁTUM GYŰJTŐ EDÉNYEK

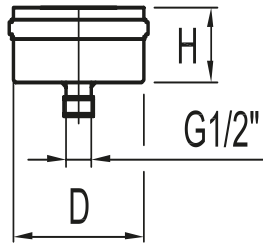

L [mm]	D [mm]	60	80	100	125
55	kód	452AN	452BN	452CN	452DN
	€/Kč	6,00/161	6,20/167	7,50/202	9,50/256

ZACHYTÁVAČ KONDENZÁTU | ZACHYTÁVAČ KONDENZÁTU | CONDENSATE SEPARATOR
 KONDENSATSAMMLER | KONDEZÁTUM LEVÁLASZTÓ

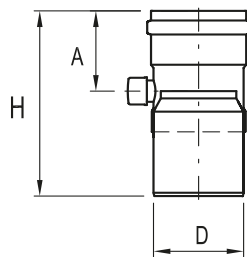

D [mm]	60	80	100	125
kód	417AN	417BN	417CN	417DN
H (mm)	140	170	170	250
A (mm)	65	75	75	160
€/Kč	18,10/490	16,00/432	20,00/541	23,00/623

REDUKCIE | REDUKCE | REDUCER | REDUKTION | BŐVÍTŐK

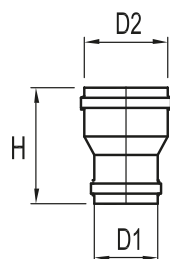

D1 [mm]	60	80
kód	417BM	419CM
D2 (mm)	80	100
H (mm)	120	120
€/Kč	11,00/298	9,70/262

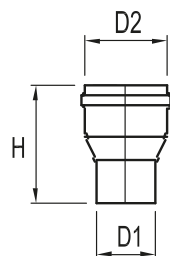

D1 [mm]	60	80	80
kód	480AR	419BR	426CR
D2 (mm)	100	100	125
H (mm)	125	120	120
€/Kč	7,50/202	9,50/256	11,00/298

Al

hliníkové komponenty | aluminium components | aluminium komponente | alumínium alkotó elemek
 RAL 9003 - biela | white | weiss | fehér színben
 EN 1856-T200-P1-D-V1-L13150-O70



Komponenty dymovodov - Al - teplotná trieda T200

NADSTAVEC | NÁSTAVEC | EXTENSION | ERWEITERUNG | TOLDÓ IDOMOK

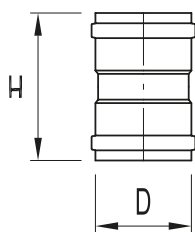

H [mm]	D [mm]	60	80	100	125
60	kód	478AM			
	€/Kč	5,60/152			
130	kód		413BM		
	€/Kč		7,50/202		
150	kód	415AM		415CM	415DM
	€/Kč	8,90/240		11,30/305	13,10/353

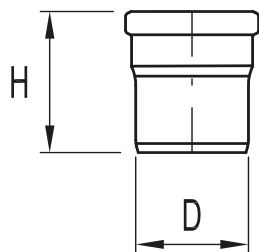

D [mm]	60
kód	478AO
H (mm)	78
€/Kč	5,60/152

Al - T200

PRÍRUBY | PŘÍRUBY | FLANGES | FLANSCH | CSATLAKOZÓ KARIMÁK

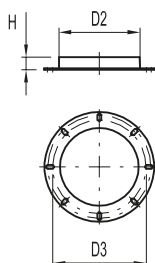

D [mm]	100
kód	441CP
D2 (mm)	97
D3 (mm)	112÷124
H (mm)	15
€/Kč	4,00/108

RÚRA TELESKOPICKÁ | TRUBKA TELESKOPICKÁ | TELESCOPIC PIPE | TELESKOPROHR | TELESZKOPIKUS CSŐ

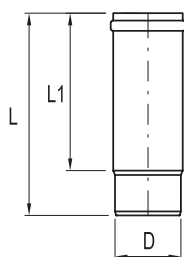

L [mm]	D [mm]	80	100
250	kód	002BtIs	002CtIs
	L1 (mm)	200	190
	€/Kč	14,40/388	15,90/430

Al

hliníkové komponenty | aluminium components | aluminium komponente | alumínium alkotó elemek
 RAL 9003 - biela | white | weiss | fehér színben
 EN 1856-T200-P1-D-V1-L13150-O70



Komponenty dymovodov - Al - teplotná trieda T200

VYÚSTENIE HORIZONTÁLNE | VYÚSTĚNÍ HORIZONTÁLNÍ | SUCTION/EXHAUST HORIZONTAL TERMINAL PIPE
 HORIZONTALER AUSLAUF | PARAPET KIVEZETÉS



L [mm]	D [mm]	60	80	100
1000	kód	010AH	010BH	010CH
	€/Kč	17,50/473	17,50/473	25,50/690

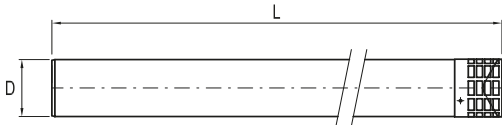

L [mm]	D [mm]	100
1000	kód	011CH
	€/Kč	27,00/732

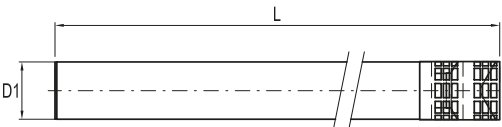

Al - T200

KOMÍNOVÁ HLAVICA-IZOLOVANÁ | KOMÍNOVÁ HLAVICE-IZOLOVANÁ | INSULATED CONICAL TERMINATION CAP
 KAMINHAUBE GEDÄMMT | SZIGETELT KÉMÉNY FEJ

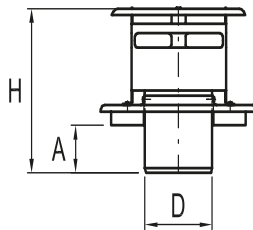

D [mm]	60	80	100	110	125
kód	416AS	417BS	418CS	419GS	420DS
H (mm)	170	170	150	180	190
A (mm)	50	50	50	50	50
€/Kč	23,70/641	18,50/501	20,80/562	29,00/786	29,00/786

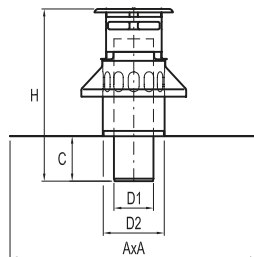

D1/D2 [mm]	80/125
kód	417BSK
H (mm)	350
C (mm)	90
A (mm)	500
€/Kč	28,00/758

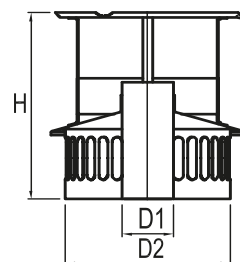

D1/D2 [mm]	80/255	110/255	125/255
kód	421GS	424GS	423GS
H (mm)	320	315	315
€/Kč	44,00/1190	45,00/1218	45,00/1218

Al

hliníkové komponenty | aluminium components | aluminium komponente | alumínium alkotó elemek
 RAL 9003 - biela | white | weiss | fehér színben
 EN 1856-T200-P1-D-V1-L13150-O70



Komponenty dymovodov - Al - teplotná trieda T200

KOMÍNOVÁ HLAVICA-IZOLOVANÁ | KOMÍNOVÁ HLAVICE-IZOLOVANÁ | INSULATED CONICAL TERMINATION CAP
 KAMINHAUBE GEDÄMMT | SZIGETELT KÉMÉNY FEJ

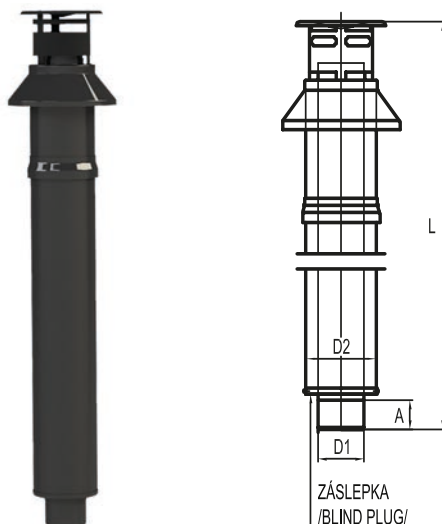

D1/D2 [mm]	80/125
kód	210BES
H (mm)	1000
A (mm)	50
€/Kč	79,00/2137

Al - T200

KRYCIA MANŽETA | KRYCÍ MANŽETA | WALL COVER ROSE | DECKUNGSMANSCHETTE | TAKARÓ MANDZSETTA

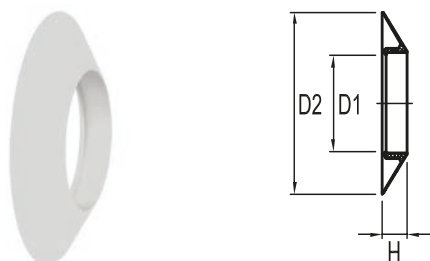

D1 [mm]	80	100	125
kód	G830B	G830C	G830D
D2 (mm)	142	163	225
H (mm)	18	18	32
€/Kč	2,50/68	3,00/82	4,00/109

KOŠÍKY | KOŠÍKY | SUCTION/ANTI-INTRUSION GRID | GITTER | KOSARAK

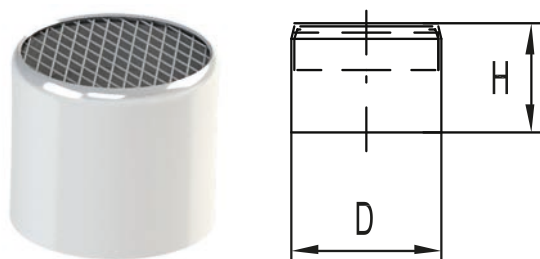

materiál: AL

D [mm]	80	100	110	125
kód	A890BH	A890CH	A890GH	A890DH
H (mm)	60	60	60	60
€/Kč	4,50/122	10,30/268	12,30/320	14,80/385

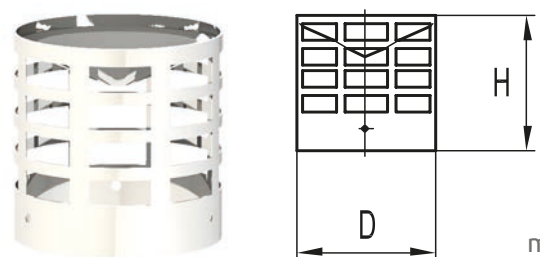

materiál: INOX

D [mm]	60	80	100	125
kód	N890AH	N890BH	N890CH	N890DH
H (mm)	75	80	80	80
€/Kč	7,00/190	7,30/197	11,10/300	21,30/576

D [mm]	100
kód	N891CH
H (mm)	135
€/Kč	14,00/378

Al

hliníkové komponenty | aluminium components | aluminium komponente | alumínium alkotó elemek
 RAL 9003 - biela | white | weiss | fehér színben
 EN 1856-T200-P1-D-V1-L13150-O70



Komponenty dymovodov - Al - teplotná trieda T200

STREŠNÁ PRECHODKA | PŘECHODKA STŘEŠNÍ | FLASHING | DURCHGANGSKRAGEN | TETŐ BORÍTÁS

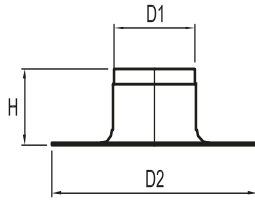

D1 [mm]	130
kód	801PS
D2 (mm)	335
H (mm)	110
€/Kč	16,00/432

STREŠNÁ PRECHODKA-ŠIKMÁ | PŘECHODKA STŘEŠNÍ-ŠIKMÁ | FLASHING FOR INCLINED ROOFS
 SCHRÄGDACHPFANNE | FERDETETŐ BORÍTÁS

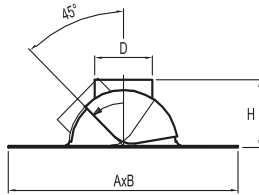
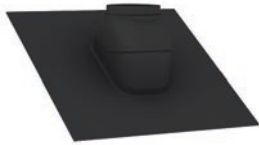

D [mm]	125
kód	810PS
H (mm)	135
AxB (mm)	500x500
€/Kč	29,00/786

PROTIDAŽOVÝ GOLIER | PROTIDEŠTOVÝ LÍMEC | RAIN COLLAR | WETTERSCHUTZKRAGEN | ESŐVEDŐ GALLÉR

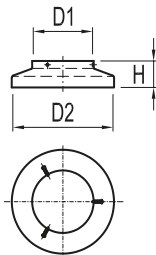
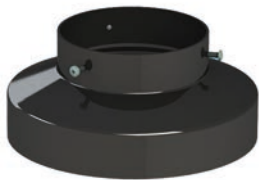

D1 [mm]	80	100	126
kód	412BY	412CY	412DY
D2 (mm)	135	135	135
H (mm)	35	60	42
€/Kč	10,00/270	10,00/270	11,00/298

KRYT KOMÍNA | KRYT KOMÍNA | WALL PLATE | KAMINDECKPLATTE | TAKARÓLEMEZ

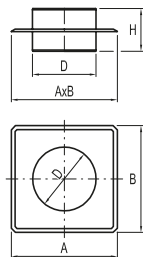

D [mm]	80	100	125	130	150
kód *	A841BL	A841CL	A841DL	A841FL	A841ML
H (mm)	100	100	100	100	100
AxB (mm)	250x250	250x250	250x250	250x250	250x250
€/Kč	8,50/231	9,00/244	9,50/256	10,10/271	10,50/285

* ZMENA KÓDU

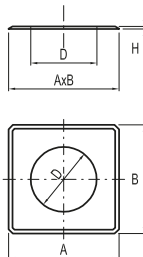

D [mm]	80	100	125	130	150
kód *	A831B	A831C	A831D	A831F	A831M
H (mm)	5	5	5	5	5
AxB (mm)	250x250	250x250	250x250	250x250	250x250
€/Kč	8,50/230	9,00/244	9,50/256	10,00/270	10,50/285

* ZMENA KÓDU

Al

hliníkové komponenty | aluminium components | aluminium komponente | alumínium alkotó elemek
 RAL 9003 - biela | white | weiss | fehér színben
 EN 1856-T200-P1-D-V1-L13150-O70



Komponenty dymvodov - Al - teplotná trieda T200

OBJÍMKA | OBJÍMKA | SLEEVE | MANSCHETTE | BILINCS

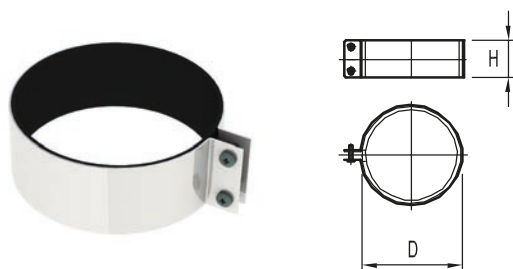

D [mm]	60	80	100	125
kód	425AO	425BO	425CO	425DO
H (mm)	40	40	40	40
€/Kč	4,00/108	4,00/108	4,00/108	4,00/108

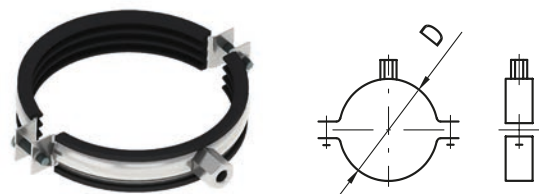

D [mm]	125	160
kód	902D	902M
H (mm)	40	40
€/Kč	7,00/189	8,00/216

Al - T200

TESNENIE | TĚSNĚNÍ | GASKET | DICHTUNG | TÖMÍTŐ GYŰRŰ



D [mm]	60	80	100
kód	810AG	810BG	810CG
€/Kč	1,60/44	1,90/52	2,50/68

UNIVERZÁLNA NAPOJOVACIA SADA | UNIVERZÁLNÍ NAPOJOVACÍ SADA | UNIVERSAL THREAD ADAPTER KIT
 ANSCHLUSS-SATZ UNIVERSAL | UNIVERZÁLIS CSATLAKOZÓ SZETT



D [mm]	60
kód	678T
€/Kč	15,50/418

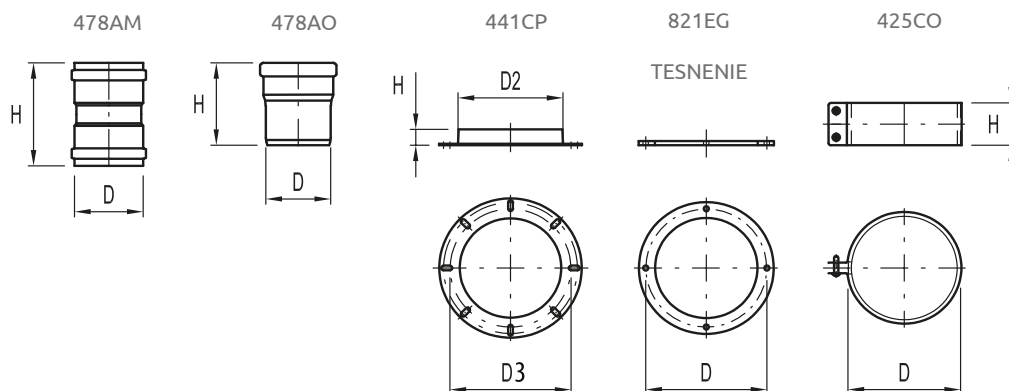



Komponenty koncentrických dymovodov - Al/Al - teplotná trieda T200

RÚRA | TRUBKA | STRAIGHT ELEMENT | ROHR | CSŐ

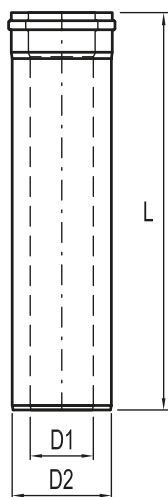

L [mm]	D1/D2 [mm]	60/100	80/125	100/150
250	kód	002T	002E	
	€/Kč	8,70/235	14,00/378	
500	kód	005T	005E	
	€/Kč	14,00/378	19,50/527	
1000	kód	010T	010E	
	€/Kč	20,00/541	26,00/704	
2000	kód	020T	020E	
	€/Kč	40,00/1082	55,00/1489	

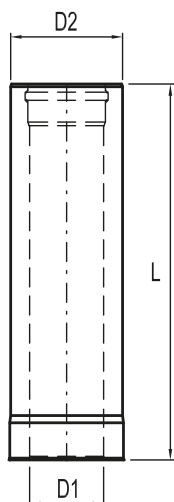

L [mm]	D1/D2 [mm]	60/100	80/125	100/150
250	kód			002MC
	€/Kč			*
500	kód			005MC
	€/Kč			25,70/695
1000	kód			010MC
	€/Kč			37,00/1001

* cena na vyžiadanie

Al/Al - T200

RÚRA S REVÍZNYM OTVOROM | TRUBKA S REVÍZNÍM OTVOREM | INSPECTION ELEMENT
 KONTROLLROHR | EGYENES ELLENŐRZŐ IDOM

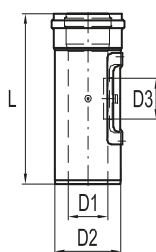

002ED

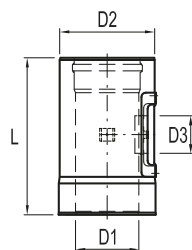

002MCD

L [mm]	D1/D2 [mm]	60/100	80/125	100/150
250	kód	002TD	002ED	002MCD
	D3 (mm)	45	60	60
	€/Kč	30,00/812	33,00/894	*

* cena na vyžiadanie

Al/Al

hliníkové komponenty | aluminium components | aluminium komponente | alumínium alkotó elemek
 RAL 9003 - biela | white | weiss | fehér színben



Komponenty koncentrických dymovodov - Al/Al - teplotná trieda T200

KOLENÁ | KOLENÁ | ELBOW | BOGEN | KÖNYÖKÖK

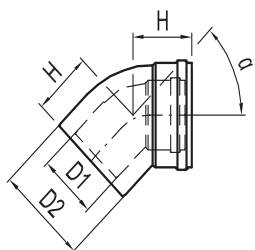

α	D1/D2 [mm]	60/100	80/125
45°	kód	045TO	045EO
	H (mm)	80	80
	€/Kč	16,00/432	22,00/595

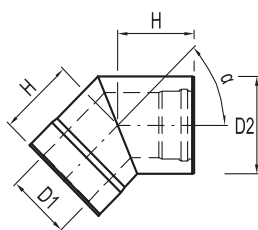

α	D1/D2 [mm]	100/150
45°	kód	045MCO
	H (mm)	118
	€/Kč	*

* cena na vyžiadanie

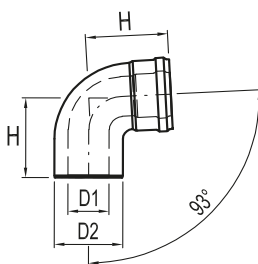

α	D1/D2 [mm]	60/100	80/125
93°	kód	093TO	093EO
	H (mm)	120	110
	€/Kč	16,00/432	22,00/595

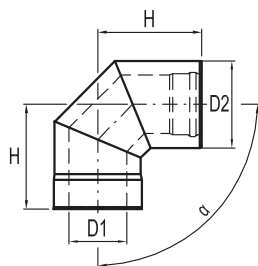

α	D1/D2 [mm]	100/150
90°	kód	090MCO
	H (mm)	165
	€/Kč	*

* cena na vyžiadanie

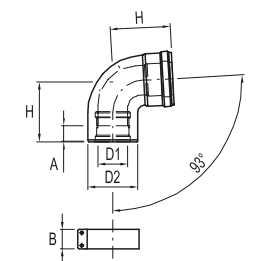

α	D1/D2 [mm]	60/100	60/100
93°	kód	093TMS	098TOS
	H (mm)	120	120
	A (mm)	11	30
	B (mm)	40	40
	€/Kč	25,00/677	20,00/541

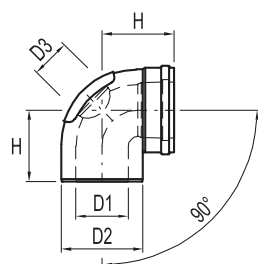

α	D1/D2 [mm]	60/100	80/125
93°	kód	093TD	
	H (mm)	110	
	D3 (mm)	45	
	€/Kč	48,00/1298	
90°	kód		093ED
	H (mm)		110
	D3 (mm)		45
	€/Kč		59,00/1597

Al/Al - T200



Komponenty koncentrických dymovodov - Al/Al - teplotná trieda T200

KOLENÁ S REVÍZNYM OTVOROM | KOLENÁ S REVÍZNÍM OTVOREM | ELBOW WITH INSPECTION
 KONTROLLBOGEN | ELLENŐRZŐ KÖNYÖKÖK

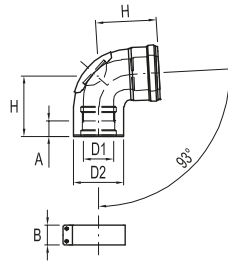

α	D1/D2 [mm]	60/100
93°	kód	093TDMS
	H (mm)	120
	A (mm)	30
	B (mm)	40
	€/Kč	55,00/1489

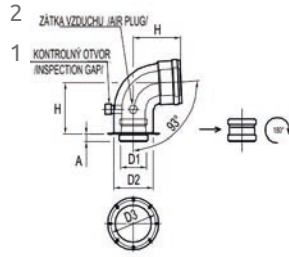

α	D1/D2 [mm]	60/100	60/100
93°	kód	093TPN	093TPN/1
	H (mm)	120	120
	D3 (mm)	112÷124	112÷124
	A (mm)	0; 11	3
	1	✓	✓
	2	✓	✓
	€/Kč	21,00/568	22,00/595

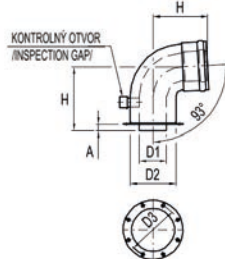

α	D1/D2 [mm]	60/100	60/100	60/100
93°	kód	093TP	093TPO	098TP
	H (mm)	120	120	120
	D3 (mm)	112÷124	112÷124	112
	A (mm)	0	26	30
	1	-	✓	-
	€/Kč	21,00/568	21,00/568	21,00/568

T-KUS | T-KUS | T-PIECE | T-STÜCK | T-IDOMOK

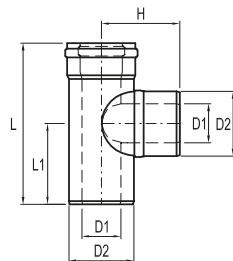

L [mm]	D1/D2 [mm]	60/100	80/125
250	kód	421TT	421ET
	L1 (mm)	125	100
	H (mm)	120	110
	€/Kč	18,00/487	34,50/934

Al/Al

hliníkové komponenty | aluminium components | aluminium komponente | alumínium alkotó elemek
 RAL 9003 - biela | white | weiss | fehér színben
 EN 1856-T200-P1-D-V1-L13150-O50



Komponenty koncentrických dymovodov - Al/Al - teplotná trieda T200

T-KUS S UZÁVEROM | T-KUS S UZÁVĚREM | T-PIECE WITH DRAIN CAP
 T-STÜCK MIT KONDENSATABLAUF | T-IDOMOK KONDENZÁTUM GYŰJTŐ EDÉNYEL

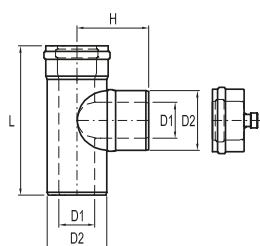

L [mm]	D1/D2 [mm]	60/100	80/125
250	kód	409TK	409EK
	H (mm)	120	110
	€/Kč	29,00/786	42,30/1143

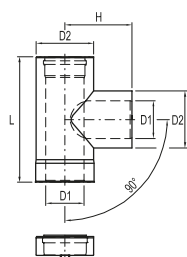

L [mm]	D1/D2 [mm]	100/150
330	kód	409MCK
	H (mm)	175
	€/Kč	80,60/2179

Al/Al - T200

KONDEZAČNÝ UZÁVER | KONDEZAČNÍ UZÁVĚR | CONDENSATION DRAIN CAP
 VERSCHLUSS MIT KONDENSATABLAUF | KONDENZÁTUM GYŰJTŐ EDÉNYEK

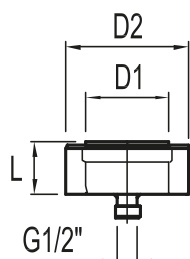
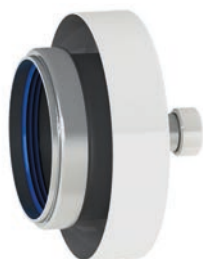

L [mm]	D1/D2 [mm]	60/100	80/125
55	kód	452TN	452EN
	€/Kč	11,00/297	13,00/351

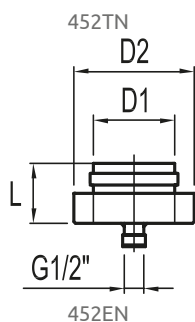

REDUKCIE | REDUKCE | REDUCER | REDUKTION | BŐVÍTŐK

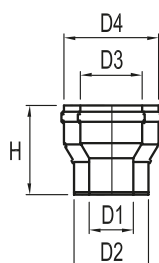

D1/D2 [mm]	60/100
kód	426TR
D3 (mm)	80
D4 (mm)	125
H (mm)	120
€/Kč	18,50/501

Komponenty koncentrických dymovodov - Al/Al - teplotná trieda T200

ROZDELOVAČE | ROZDĚLOVAČE | SPLITTER | VERTEILER | OSZTÓ IDOMOK

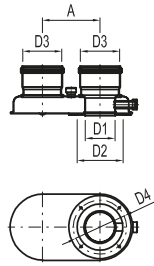

D1/D2 [mm]	60/100
kód	422TBL
D3 (mm)	80
D4 (mm)	112
A (mm)	120
€/Kč	24,00/649

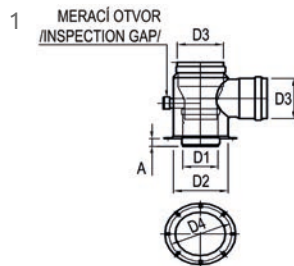

D1/D2 [mm]	60/100	60/100
kód	422TP	422TPN
D3 (mm)	80	80
D4 (mm)	112÷124	112÷124
A (mm)	12	12
1	-	✓
€/Kč	24,00/649	21,00/568

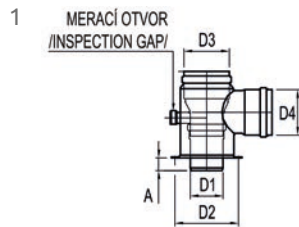

D1/D2 [mm]	60/100	60/100
kód	423TP	423TPN
D3 (mm)	80	80
D4 (mm)	112÷124	112÷124
A (mm)	25	25
1	-	✓
€/Kč	17,50/473	17,50/473

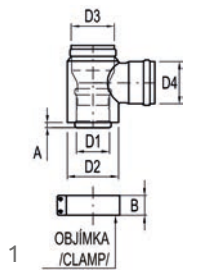

D1/D2 [mm]	60/100	60/100
kód	422TTM	422TTMO
D3 (mm)	80	80
D4 (mm)	80	80
A (mm)	10	20
B (mm)	40	-
1	✓	-
€/Kč	21,00/569	19,10/514

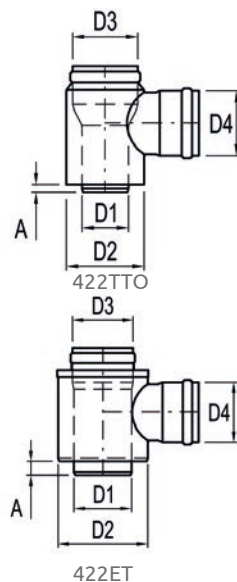

D1/D2 [mm]	60/100	80/125
kód	422TTO	422ET
D3 (mm)	80	80
A (mm)	10	20
€/Kč	17,50/473	24,00/649

Al/Al - T200



Komponenty koncentrických dymovodov - Al/Al - teplotná trieda T200

ZACHYTÁVAČ KONDENZÁTU | ZACHYTÁVAČ KONDENZÁTU | CONDENSATE SEPARATOR
 KONDENSATSAMMLER | KONDENZÁTUM LEVÁLASZTÓ

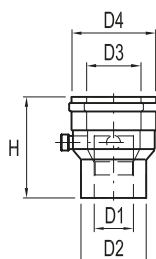

D1/D2 [mm]	60/100
kód	417EON
D3 (mm)	80
D4 (mm)	125
H (mm)	155
€/Kč	32,00/866

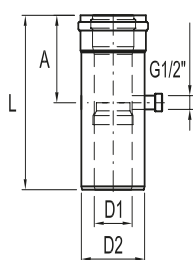

D1/D2 [mm]	60/100	80/125
kód	417TN	417EN
A (mm)	75	125
H (mm)	170	250
€/Kč	25,00/677	32,00/866

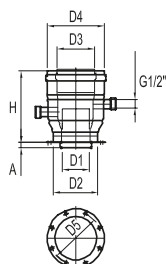

D1/D2 [mm]	60/100	60/100
kód	417ENM	417TEN
D3 (mm)	80	80
D4 (mm)	125	125
D5 (mm)	112÷124	112÷124
H (mm)	170	165
A (mm)	11	3
€/Kč	32,00/866	32,00/866



D1/D2 [mm]	60/100	60/100	60/100	60/100	60/100
kód	417TP	417TPO	418TP	417TPP	414TP
H (mm)	115	115	115	135	145
D3 (mm)	60	60	60	60	60
D4 (mm)	100	100	100	100	100
D5 (mm)	112÷124	112÷124	112÷124	112 (PPs)	112÷124
A (mm)	-	-	-	-	30
€/Kč	24,00/655	24,30/655	16,00/424	24,00/655	20,00/541

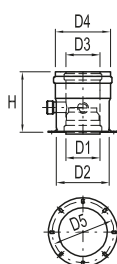

417TP

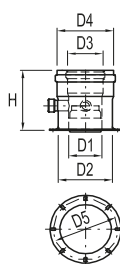

417TPO

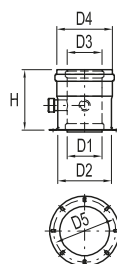

418TP

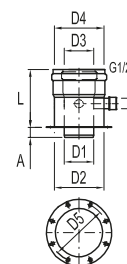

414TP

Al/Al

hliníkové komponenty | aluminium components | aluminium komponente | aluminium alkotó elemek
 RAL 9003 - biela | white | weiss | fehér színben
 EN 1856-T200-P1-D-V1-L13150-O50

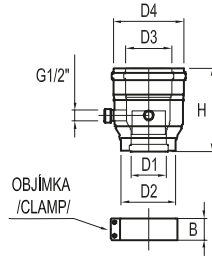
Komponenty koncentrických dymovodov - Al/Al - teplotná trieda T200

D1/D2 [mm]	60/100
kód	433TEM
H (mm)	250
D3 (mm)	80
D4 (mm)	125
A (mm)	160
€/Kč	32,00/867

PRÍRUBY | PŘÍRUBY | FLANGES | FLANSCH | CSATLAKOZÓ KARIMÁK

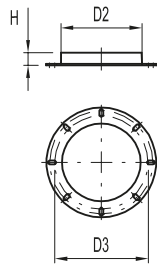
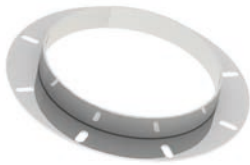

D [mm]	100
kód	441CP
D2 (mm)	97
D3 (mm)	112÷124
H (mm)	15
€/Kč	4,00/108

VYÚSTENIE HORIZONTÁLNE | VYÚSTĚNÍ HORIZONTÁLNÍ | SUCTION/EXHAUST HORIZONTAL TERMINAL PIPE
 HORIZONTALER AUSLAUF | PARAPET KIVEZETÉS



D1/D2 [mm]	80/125	80/125
kód	007EH	012EH/1
L (mm)	700	1060
€/Kč	25,10/677	25,50/689

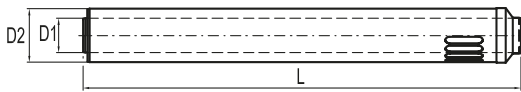

D1/D2 [mm]	60/100	60/100
kód	007TH	012TH
L (mm)	750	1000
€/Kč	19,00/515	21,00/569

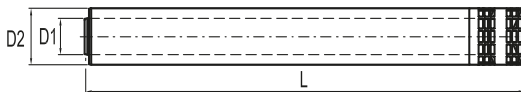

D1/D2 [mm]	60/100
kód	011TH
L (mm)	1000
€/Kč	27,00/732

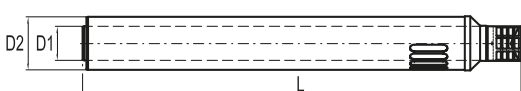
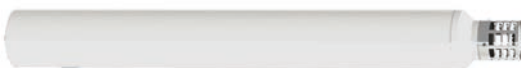

D1/D2 [mm]	80/125
kód	012EH
L (mm)	1140
€/Kč	28,00/758

Al/Al

hliníkové komponenty | aluminium components | aluminium komponente | alumínium alkotó elemek
 RAL 9003 - biela | white | weiss | fehér színben
 EN 1856-T200-P1-D-V1-L13150-O50



Komponenty koncentrických dymovodov - Al/Al - teplotná trieda T200

STREŠNÉ KOMÍNY | STŘEŠNÍ KOMÍNY | ROOF MOUNTED CHIMNEYS | DACHTEILE | TETŐÁTVÉZETESEK

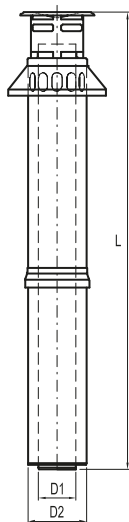

D1/D2 [mm]	60/100	80/125
kód	011TSL-9005	011ESL-9005
L (mm)	1110	1120
€/Kč	49,00/1326	49,00/1326

Al/Al - T200

KOMÍNOVÉ HLAVICE | KOMÍNOVÉ HLAVICE | FLUE TERMINATIONS | KAMINHAUBE | KÉMÉNY FEJ

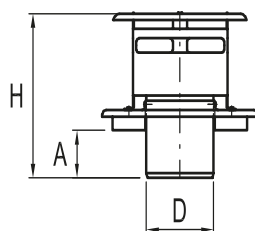

D [mm]	60	80	100	110	125
kód	416AS	417BS	418CS	419GS	420DS
H (mm)	170	170	150	180	190
A (mm)	50	50	50	50	50
€/Kč	23,70/641	18,50/501	20,80/562	29,00/786	29,00/786

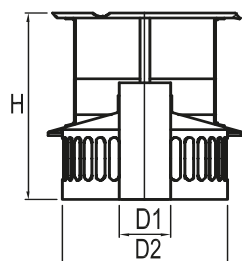

D1/D2 [mm]	160/255
kód	427HS
H (mm)	290
€/Kč	45,00/1218

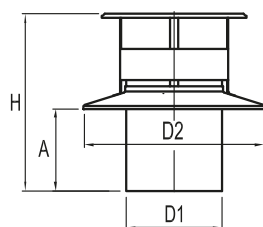

D1/D2 [mm]	160/300
kód	428HS
H (mm)	290
A (mm)	135
€/Kč	40,00/1082

Al

hliníkové komponenty | aluminium components | aluminium komponente | aluminium alkotó elemek
 pre priemyselné vykurovanie | for industrial heating | industrieheinzug | ipari fűtés technika
 bez povrchovej úpravy | uncoated | unbeschichtet | bevonat nélküül
 EN 1856-T300-P1-D-V1-L10200+13150-O100 | EN 1856-T300-P1-D-V1-L10200+13150+11090-O70



Komponenty dymovodov pre priemyselné vykurovanie - Al - teplotná trieda T300

RÚRA | TRUBKA | STRAIGHT ELEMENT | ROHR | CSŐ

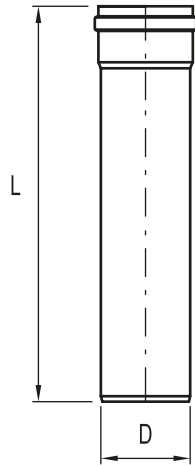

L [mm]	D [mm]	60	80	100	125	130
250	kód		102B	102C	102D	
	€/Kč		4,70/127	6,10/165	9,30/251	
350	kód			103C		
	€/Kč			9,00/244		
500	kód	105A	105B	105C	105D	105F
	€/Kč	5,50/148	5,70/155	9,00/244	12,50/338	12,50/338
1000	kód	110A	110B	110C	110D	110F
	€/Kč	8,40/230	9,60/259	13,90/376	16,00/432	18,80/508
1500	kód			115C		
	€/Kč			21,80/589		
2000	kód		120B	120C	120D	
	€/Kč		18,70/506	26,80/725	30,00/812	

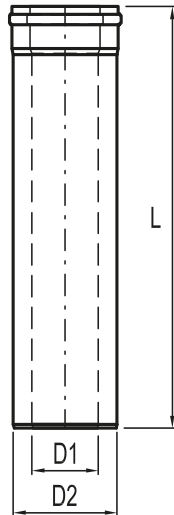

L [mm]	D1/D2 [mm]	80/125
250	kód	102E
	€/Kč	14,00/378
500	kód	105E
	€/Kč	18,00/487
1000	kód	110E
	€/Kč	24,00/649
2000	kód	120E
	€/Kč	52,00/1597

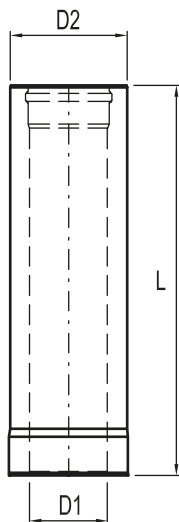

L [mm]	D1/D2 [mm]	100/150	125/180	130/200
250	kód	102MC		
	€/Kč	17,00/460		
500	kód	105MC	105DU	105NF
	€/Kč	22,00/595	*	33,00/891
1000	kód	110MC	110DU	110NF
	€/Kč	29,00/786	*	44,00/1188
2000	kód	120MC		
	€/Kč	58,00/1569		

* cena na vyžiadanie

Al - T300

Al

hliníkové komponenty | aluminium components | aluminium komponente | aluminium alkotó elemek
 pre priemyselné vykurovanie | for industrial heating | industrieheinzug | ipari fűtéstechnika
 bez povrchovej úpravy | uncoated | unbeschichtet | bevonat nélkül
 EN 1856-T300-P1-D-V1-L10200+13150-O100 | EN 1856-T300-P1-D-V1-L10200+13150+11090-O70



Komponenty dymovodov pre priemyselné vykurovanie - Al - teplotná trieda T300

ZLUČOVAČ | SLUČOVAČ | COMBINER | LUFTKOMBINER | EGYESÍTŐ IDOMOK

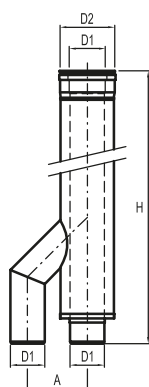

80/125

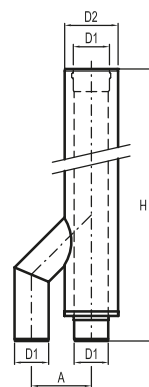

100/150 a väčšie priemery

H [mm]	D1/D2 [mm]	80/125	100/150	125/180	130/200
300	kód	104EBV			
	A (mm)	110			
	€/Kč	*			
1000	kód	110EBV	110MCV		110NFV
	A (mm)	120	204		225
	€/Kč	49,00/1326	49,00/1326		69,00/1863
1000	kód	111EBV	111MCV	111DUV	
	A (mm)	140	140	225	
	€/Kč	49,00/1326	49,00/1326	*	

* cena na vyžiadanie

Al - T300

RÚRA FLEXIBILNÁ | TRUBKA FLEXIBILNÍ | FLEXIBLE PIPE | ABGASROHR FLEXIBEL | FLEXIBILIS CSŐ



AL-iba na prisávanie vzduchu

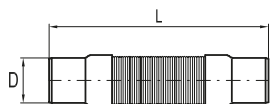

AL-iba na prisávanie vzduchu

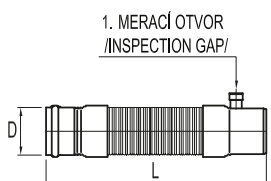

D [mm]	80	100
kód	105BF	105CF
L (mm)	425÷1250	425÷1250
€/Kč	15,20/411	18,50/501

D [mm]	80
kód	106BF
L (mm)	425÷1250
€/Kč	14,80/400

D [mm]	80	100	125	130
kód	N105BF	N105CF	N105DF	N105FF
L (mm)	500	500	500	500
1	✓			
€/Kč	11,40/308	23,00/622	31,00/839	35,80/966
kód	N110BF	N110CF	N110DF	
L (mm)	1000	1000	1000	
1	✓			
€/Kč	15,00/413	27,10/732	39,00/1055	

Al

hliníkové komponenty | aluminium components | aluminium komponente | alumínium alkotó elemek
 pre priemyselné vykurovanie | for industrial heating | industrieheizung | ipari fűtéstechnika
 bez povrchovej úpravy | uncoated | unbeschichtet | bevonat nélkül
 EN 1856-T300-P1-D-V1-L10200+13150-O100 | EN 1856-T300-P1-D-V1-L10200+13150+11090-O70



Komponenty dymovodov pre priemyselné vykurovanie - Al - teplotná trieda T300

FLEXO-INOX BEZ KONCOVIEK | FLEXO-INOX BEZ KONCOVEK | INOX FLEXIBLE PIPES WITHOUT CAPS
 EDELSTAHLABGASROHR FLEXIBEL OHNE BEENDIGUNGEN | FLEXIBILIS INOX CS



D [mm]	80	100	130
kód	N111BF	N111CF	N110FF
€/Kč	11,00/298	13,50/365	45,30/1223

FLEXO-KONCOVKY | FLEXO-KONCOVKY | FLEX JUNCTION | BEENDIGUNGEN | FLEXIBILIS CSATLAKOZÓ VÉGEKEL

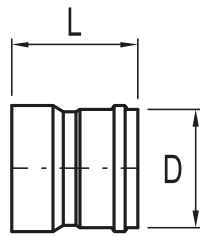

D [mm]	80	100	125
kód	501BM	501CM	502DM
L (mm)	110	115	130
€/Kč	6,50/176	6,50/176	7,00/189

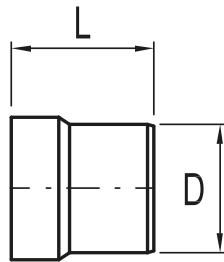

D [mm]	80	100	125
kód	501BO	501CO	501DO
L (mm)	110	110	125
€/Kč	6,10/165	6,30/168	6,50/176

KOLENÁ | KOLENÁ | ELBOW | BOGEN | KÖNYÖKÖK

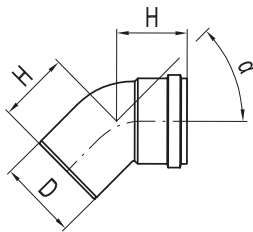

α	D [mm]	60	80	100	125
45°	kód	145AO	145BO	145CO	145DO
	H (mm)	80	70	80	80
	€/Kč	6,70/181	6,70/181	9,40/254	12,60/340

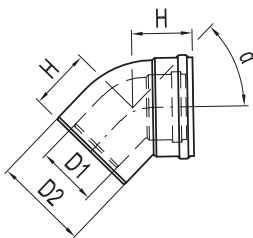

α	D [mm]	80/125
45°	kód	145EO
	H (mm)	110
	€/Kč	21,00/568

Al - T300

Al

hliníkové komponenty | aluminium components | aluminium komponente | aluminium alkotó elemek
 pre priemyselné vykurovanie | for industrial heating | industrieheinzug | ipari fűtéstechika
 bez povrchovej úpravy | uncoated | unbeschichtet | bevonat nélkül
 EN 1856-T300-P1-D-V1-L10200+13150-O100 | EN 1856-T300-P1-D-V1-L10200+13150+11090-O70



Komponenty dymovodov pre priemyselné vykurovanie - Al - teplotná trieda T300

KOLENÁ | KOLENÁ | ELBOW | BOGEN | KÖNYÖKÖK

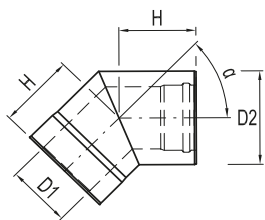

α	D1/D2[mm]	100/150	125/180
45°	kód	145MCO	145DUO
	H (mm)	170	-
	€/Kč	52,00/1406	*

* cena na vyžiadanie

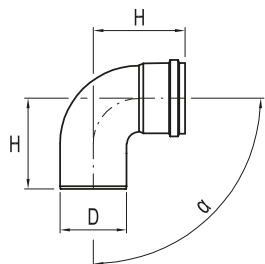

α	D [mm]	80	100	125
90°	kód	190BO		190DO
	H (mm)	90		110
	€/Kč	6,70/181		12,60/340
93°	kód		193CO	
	H (mm)		120	
	€/Kč		9,40/254	

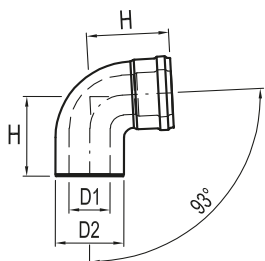

α	D1/D2[mm]	80/125
90°	kód	193EO
	H (mm)	110
	€/Kč	21,00/569

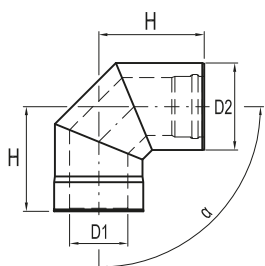

α	D1/D2[mm]	100/150	125/180
90°	kód	190MCO	190DUO
	H (mm)	165	-
	€/Kč	52,00/1406	*

* cena na vyžiadanie

T-KUS | T-KUS | T-PIECE | T-STÜCK | T-IDOMOK

T-KUS | T-KUS | T-PIECE | T-STÜCK | T-IDOMOK

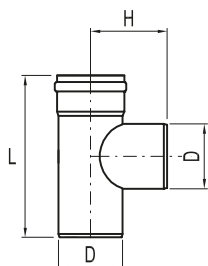

L [mm]	D [mm]	80	100	125
250	kód	521BT	521CT	521DT
	L1 (mm)	100	125	100
	H (mm)	110	120	110
	€/Kč	13,60/367	16,50/446	23,00/623

Al

hliníkové komponenty
pre priemyselné vykurovanie
bez povrchovej úpravy
EN 1856-T300-P1-D-V1-L10200+13150-O100

aluminium components
for industrial heating
uncoated
EN 1856-T300-P1-D-V1-L10200+13150-O100

aluminium komponente
industriehinzug
unbeschichtet
EN 1856-T300-P1-D-V1-L10200+13150+11090-O70

aluminium alkotó elemek
ipari fűtéstechnika
bevonat nélküli
EN 1856-T300-P1-D-V1-L10200+13150+11090-O70



Komponenty dymovodov pre priemyselné vykurovanie - Al - teplotná trieda T300

T-KUS | T-KUS | T-PIECE | T-STÜCK | T-IDOMOK

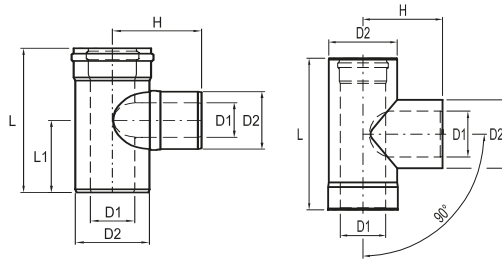

80/125

100/150 a väčšie priemery

D1/D2[mm]	80/125	100/150	125/180
kód	521ET	521MCT	521DUT
L (mm)	250	330	-
H (mm)	110	170	-
€/Kč	33,50/905	57,90/1566	*

* cena na vyžiadanie

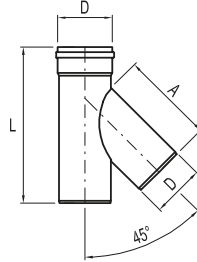

α	D [mm]	80	100
45°	kód	545BT	545CT
	L (mm)	250	300
	A (mm)	150	170
	€/Kč	16,50/446	21,00/569

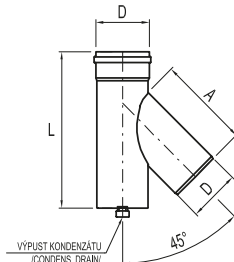

α	D [mm]	80	100
45°	kód	545BNO	545CNO
	L (mm)	280	300
	A (mm)	185	215
	€/Kč	25,00/677	26,50/716

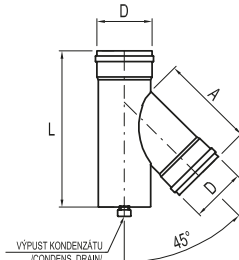

α	D [mm]	100	125
45°	kód	545CNM	545DNM
	L (mm)	300	330
	A (mm)	180	205
	€/Kč	27,00/732	35,30/954

T-KUS S UZÁVEROM | T-KUS S UZÁVĚREM | T-PIECE WITH DRAIN CAP
T-STÜCK MIT KONDENSATABLAUF | T-IDOMOK KONDENZÁTUM GYÚJTÓ EDÉNYE

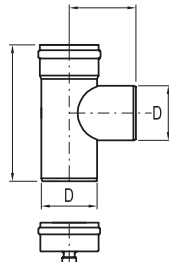

D [mm]	80	100	125
kód	509BK	509CK	509DK
L (mm)	250	250	250
H (mm)	110	120	110
€/Kč	19,00/515	22,50/609	33,00/895

Al

hliníkové komponenty | aluminium components | aluminium komponente | aluminium alkotó elemek
 pre priemyselné vykurovanie | for industrial heating | industrieheizung | ipari fűtéstechika
 bez povrchovej úpravy | uncoated | unbeschichtet | bevonat nélkül
 EN 1856-T300-P1-D-V1-L10200+13150-O100 | EN 1856-T300-P1-D-V1-L10200+13150+11090-O70



Komponenty dymovodov pre priemyselné vykurovanie - Al - teplotná trieda T300

T-KUS S UZÁVEROM | T-KUS S UZÁVĚREM | T-PIECE WITH DRAIN CAP
 T-STÜCK MIT KONDENSATABLAUF | T-IDOMOK KONDENZÁTUM GYŰJTŐ EDÉNYE

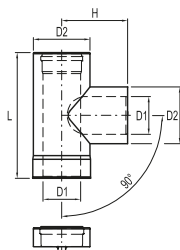

D1/D2 [mm]	80/125	100/150	125/180
kód	509EK	509MCK	509DUK
L (mm)	250	330	-
H (mm)	110	170	-
€/Kč	39,00/1068	75,00/2029	*

* cena na vyžiadanie

KONDEZAČNÝ UZÁVER | KONDEZAČNÍ UZÁVĚR | CONDENSATION DRAIN CAP
 VERSCHLUSS MIT KONDENSATABLAUF | KONDENZÁTUM GYŰJTŐ EDÉNYEK

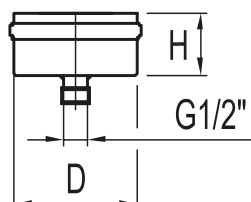

D [mm]	80	100	125
kód	552BN	552CN	552DN
L (mm)	55	55	55
€/Kč	6,00/161	7,00/189	9,00/244

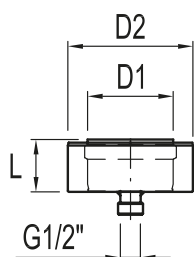
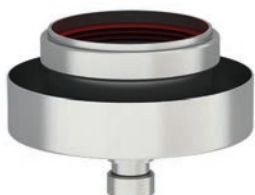

D1/D2 [mm]	80/125	100/150	125/180
kód	552EN	552MCN	552DUN
L (mm)	55	50	-
€/Kč	12,00/324	17,40/468	*

* cena na vyžiadanie

REDUKCIE | REDUKCE | REDUCER | REDUKTION | BŐVÍTŐK

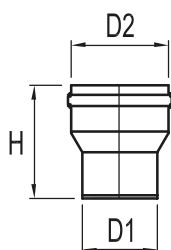

D1/D2 [mm]	80/100	100/125	125/130	130/125
kód	519BR	526CR	510FDR	510DFR
L (mm)	120	120	125	125
€/Kč	9,20/249	10,00/270	11,00/298	11,00/298

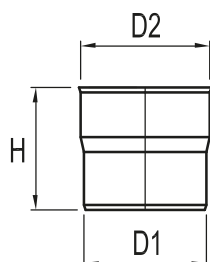

D1/D2 [mm]	125/130
kód	510DFK
H (mm)	125
€/Kč	9,50/257

Al - T300

Al

hliníkové komponenty
pre priemyselné vykurovanie
bez povrchovej úpravy

aluminium components
for industrial heating
uncoated

aluminium componente
industrieheinzug
unbeschichtet

aluminium alkotó elemek
ipari fűtéstechnika
bevonat nélkü

EN 1856-T300-P1-D-V1-L10200+13150-O100

EN 1856-T300-P1-D-V1-L10200+13150+11090-O70



Komponenty dymovodov pre priemyselné vykurovanie - Al - teplotná trieda T300

REDUKCIE | REDUKCE | REDUCER | REDUKTION | BŐVÍTŐK

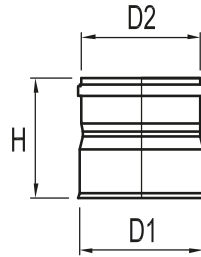

D1/D2 [mm]	130/125
kód	511DFK
H (mm)	125
€/Kč	9,00/243

NADSTAVEC | NÁSTAVEC | EXTENSION | ERWEITERUNG | TOLDÓ IDOMOK

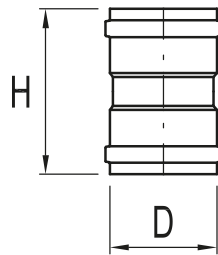

D [mm]	80	100	-
kód	513BM	515CM	515DM
H (mm)	130	150	-
€/Kč	6,90/186	10,00/270	12,20/330

RÚRA TELESKOPIKÁ | TRUBKA TELESKOPIKÁ | TELESCOPIC PIPE | TELESKOPROHR | TELESZKOPIKUS CSŐ

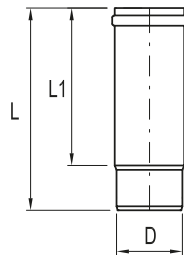

D [mm]	80	100
kód	102BtIs	102CtIs
L (mm)	250	250
L1 (mm)	200	190
€/Kč	14,00/378	15,00/405

RÚRA TELESKOPIKÁ | TRUBKA TELESKOPIKÁ | TELESCOPIC PIPE | TELESKOPROHR | TELESZKOPIKUS CSŐ

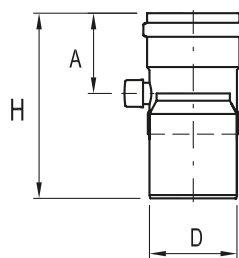

D [mm]	80	100	125
kód	517BN	517CN	517DN
H (mm)	170	170	250
A (mm)	75	75	165
€/Kč	15,10/408	20,00/541	20,00/541

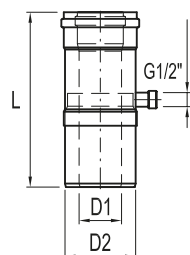

D1/D2 [mm]	80/125
kód	517EN
H (mm)	250
A (mm)	125
€/Kč	31,00/837

Al - T300

Al

hliníkové komponenty | aluminium components | aluminium komponente | alumínium alkotó elemek
 pre priemyselné vykurovanie | for industrial heating | industrieheinzug | ipari fűtéstechika
 bez povrchovej úpravy | uncoated | unbeschichtet | bevonat nélkül
 EN 1856-T300-P1-D-V1-L10200+13150-O100 | EN 1856-T300-P1-D-V1-L10200+13150+11090-O70



Komponenty dymovodov pre priemyselné vykurovanie - Al - teplotná trieda T300

KOMÍNOVÉ HLAVICE | KOMÍNOVÉ HLAVICE | FLUE TERMINATIONS | KAMINHAUBE | KÉMÉNY FEJ

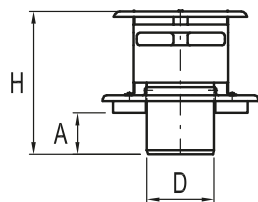

D [mm]	80	100	125	130
kód	517BS	518CS	520DS	521FS
H (mm)	170	150	190	190
A (mm)	50	50	50	75
€/Kč	17,50/473	19,80/536	28,00/757	28,00/757

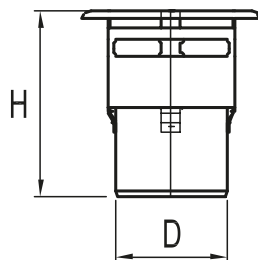

D [mm]	100
kód	519CS
H (mm)	165
€/Kč	15,00/406

KOMÍNOVÉ HLAVICE | KOMÍNOVÉ HLAVICE | FLUE TERMINATIONS | KAMINHAUBE | KÉMÉNY FEJ

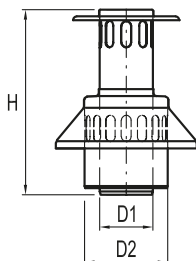

D1/D2 [mm]	80/125
kód	517EBV
H (mm)	280
€/Kč	33,00/894

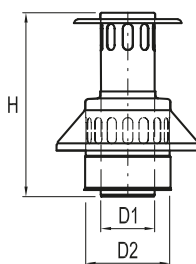

D1/D2 [mm]	100/150	100/150	125/180	130/200
kód	518MCV	519MCV	521DUV	521NFV
H (mm)	280	655	-	275
€/Kč	33,00/894	47,00/1270	*	42,00/1136

* cena na vyžiadanie

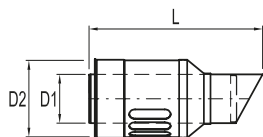

D1/D2 [mm]	80/125	100/150	125/180
kód	550EBH	550MCH	550DUH
L (mm)	300	300	-
€/Kč	24,00/648	30,00/812	*

* cena na vyžiadanie

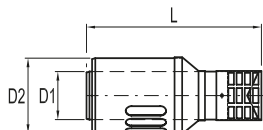

D1/D2 [mm]	80/125	100/150	125/180
kód	555EBH	555MCH	555DUH
L (mm)	310	310	-
€/Kč	29,00/786	35,00/948	*

* cena na vyžiadanie

Al - T300

Al

hliníkové komponenty | aluminium components | aluminium komponente | aluminium alkotó elemek
 pre priemyselné vykurovanie | for industrial heating | industrieheizung | ipari fűtés technika
 bez povrchovej úpravy | uncoated | unbeschichtet | bevonat nélkül
 EN 1856-T300-P1-D-V1-L10200+13150-O100 | EN 1856-T300-P1-D-V1-L10200+13150+11090-O70



Komponenty dymovodov pre priemyselné vykurovanie - Al - teplotná trieda T300

TEPELNÝ VÝMENNÍK | TEPELNÝ VÝMĚNÍK | HEAT EXCHANGER | WÄRMETAUSCHER | HŐCSERÉLŐ

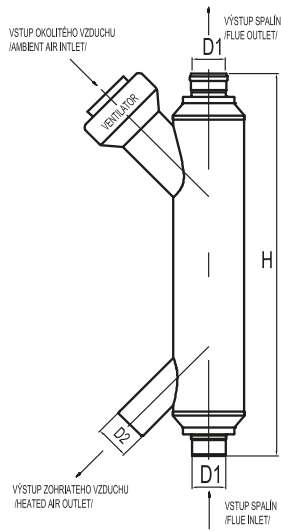

D1/D2 [mm]	100/100	100/100
kód	VYMCC250	VYMCM450
H (mm)	1150	1150
€/Kč	*	*

* cena na vyžiadanie

RÚRA IZOLOVANÁ | TRUBKA IZOLOVANÁ | INSULATED PIPE | ROHR GEDÄMMT | SZIGETELT CSŐ

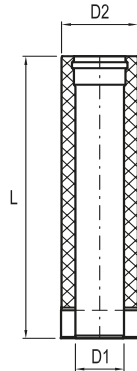

L [mm]	D1/D2 [mm]	80/125	100/150	125/180
500	kód	105BI	105CI	105DI
	€/Kč	25,00/675	30,00/810	*
1000	kód	110BI	110CI	110DI
	€/Kč	33,00/894	38,00/1027	47,00/1271
2000	kód	120BI	120CI	120DI
	€/Kč	66,00/1785	75,00/2029	*

* cena na vyžiadanie

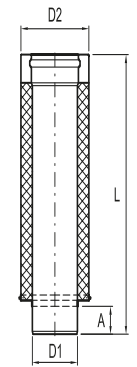

L [mm]	D1/D2 [mm]	100/150	125/180
500	kód	105CIS	105DIS
	A (mm)	50	50
	€/Kč	*	*
1000	kód	110CIS	110DIS
	A (mm)	50	50
	€/Kč	43,50/1176	49,50/1339

* cena na vyžiadanie

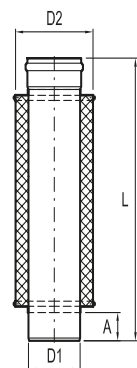

L [mm]	D1/D2 [mm]	100/150	125/180
1000	kód	110CIS2	110DIS2
	A (mm)	50	50
	€/Kč	48,00/1298	*

* cena na vyžiadanie

Al - T300

Al

hliníkové komponenty | aluminium components | aluminium komponente | alumínium alkotó elemek
 pre priemyselné vykurovanie | for industrial heating | industrieheinzug | ipari fűtéstechika
 bez povrchovej úpravy | uncoated | unbeschichtet | bevonat nélkül
 EN 1856-T300-P1-D-V1-L10200+13150-O100 | EN 1856-T300-P1-D-V1-L10200+13150+11090-O70



Komponenty dymovodov pre priemyselné vykurovanie - Al - teplotná trieda T300

KOLENO IZOLOVANÉ | KOLENO IZOLOVANÉ | INSULATED ELBOW | BOGEN GEDÄMMT | SZIGETELT KÖNYÖKÖK

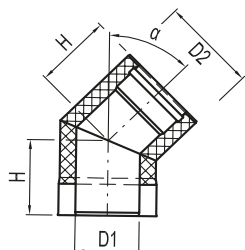

α	D1/D2[mm]	80/125	100/150	125/180
45°	kód	145BI	145CI	145DI
	H (mm)	80	117	-
	€/Kč	27,00/729	35,00/945	*

* cena na vyžiadanie

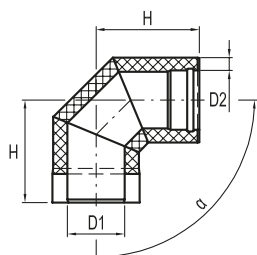

α	D1/D2[mm]	80/125	100/150	125/180
90°	kód	190BI	190CI	190DI
	H (mm)	110	170	-
	€/Kč	27,00/729	35,00/945	*

* cena na vyžiadanie

T-KUS IZOLOVANÝ | T-KUS IZOLOVANÝ | INSULATED T-PIECE | T-STÜCK GEDÄMMT | SZIGETELT T-IDOMOK

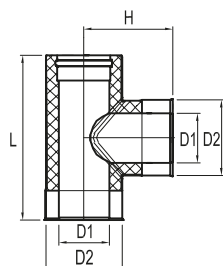

D1/D2 [mm]	80/125	100/150	125/180
kód	521BTIM	521CTIM	521DTIM
L (mm)	250	330	-
L1 (mm)	100	166	-
H (mm)	110	205	-
€/Kč	31,00/839	42,00/1136	*

* cena na vyžiadanie

T-KUS S UZÁVEROM, IZOLOVANÝ | T-KUS IZOLOVANÝ S UZÁVĚREM | INSULATED T-PIECE WITH DRAIN CAP
 T-STÜCK MIT KONDENSATABLAUF GEDÄMMT | SZIGETELT T-IDOMOK KONDENZÁTUM GYŰJTŐ EDÉNYEL

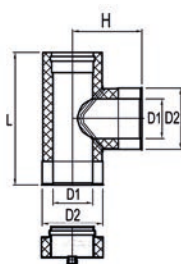
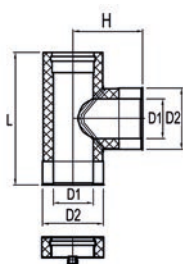

D1/D2 [mm]	80/125	100/150	125/180
kód	509BKIM	509CKIM	509DKIM
L (mm)	250	330	-
H (mm)	110	200	-
€/Kč	44,00/1191	59,00/1596	*

* cena na vyžiadanie

Al - T300

Al

hliníkové komponenty | aluminium components | aluminium komponente | alumínium alkotó elemek
 pre priemyselné vykurovanie | for industrial heating | industrieheinzug | ipari fűtés technika
 bez povrchovej úpravy | uncoated | unbeschichtet | bevonat nélkül
 EN 1856-T300-P1-D-V1-L10200+13150-O100 | EN 1856-T300-P1-D-V1-L10200+13150+11090-O70

Komponenty dymovodov pre priemyselné vykurovanie - Al - teplotná trieda T300

KONDEZNAČNÝ UZÁVER-IZOLOVANÝ | KONDEZNAČNÍ UZÁVÉR IZOLOVANÝ | INSULATED CONDENSATION DRAIN CAP
 KONDENSATFALLE | SZIGETELT KONDENZÁTUM GYŰJTŐ EDÉNYEK

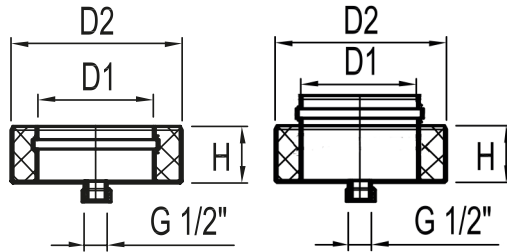
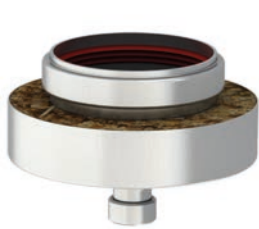

D1/D2 [mm]	80/125	100/150	125/180
kód	552BNI	552CNI	552DNI
H (mm)	50	50	-
€/Kč	13,00/351	17,40/468	*

* cena na vyžiadanie

KOMÍNOVÉ HLAVICE | KOMÍNOVÉ HLAVICE | FLUE TERMINATIONS | KAMINHAUBE | KÉMÉNY FEJ

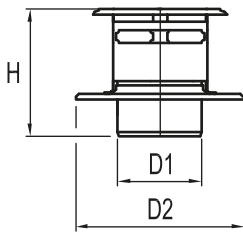

D1/D2 [mm]	80/185	100/200	110/230	125/180
kód	517BSI	518CSI	519GSI	518DSI
H (mm)	150	150	150	-
€/Kč	20,00/541	20,00/541	29,00/785	*

* cena na vyžiadanie

VYÚSTENIE HORIZONTÁLNE | VYÚSTĚNÍ HORIZONTÁLNÍ | SUCTION/EXHAUST HORIZONTAL TERMINAL PIPE
 HORIZONTALER AUSLAUF | PARAPET KIVEZETÉS

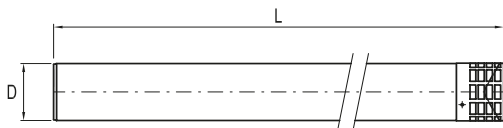

L [mm]	D [mm]	80	100
1000	kód	110BH	111CH
	€/Kč	16,50/446	26,00/704

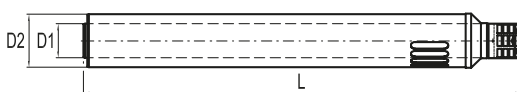

L [mm]	D1/D2 [mm]	80/125
1140	kód	112EH
	€/Kč	26,30/711

TESZENIE | TĚSNĚNÍ | GASKET | DICHTUNG | TÖMÍTŐ GYŰRŰ



D1/D2 [mm]	80	100	125
kód	810BGC	518CSI	519GSI
materiál	silikón	silikón	silikón
€/Kč	2,70/73	2,90/78	3,50/95

INOX SRS

komponenty INOX | components INOX | komponente | INOX elemek
 bez povrchovej úpravy | uncoated | unbeschichtet | bevonat nélkül
 EN 1856 - T400 - N1 - W - V2 - L50060 - O(100) - L50100
 EN 1856 - T400 - N1 - D - V3 - L50060 - G(300) - L50100



Komponenty dymovodov - INOX jednovrstvový systém Kaminodur SRS- teplotná trieda T400

RÚRA | TRUBKA | PIPE | ROHR | CSŐ

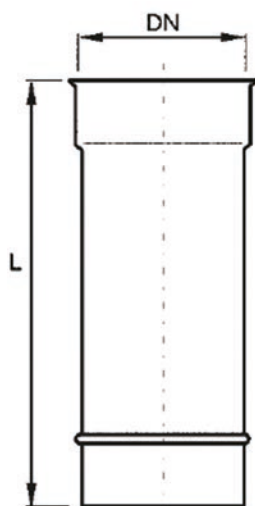

kód	ROM 1.10.03					
DN [mm]	L [mm]	€/Kč	L [mm]	€/Kč	L [mm]	€/Kč
100	250	8,30/215	500	11,80/306	1000	18,50/481
113		8,80/228		12,00/313		19,20/499
120		9,60/249		12,70/330		19,90/516
130		9,60/249		13,40/349		20,80/541
140		9,80/254		13,70/356		21,70/563
150		10,00/259		13,90/363		22,70/589
160		10,90/283		15,20/394		24,70/641
180		11,70/304		16,50/430		27,00/702
200		12,70/330		17,00/443		29,80/774
225		14,30/373		20,00/521		34,70/903
250		15,70/409		21,60/562		37,10/965
300		19,40/505		24,90/648		44,80/1165
355		20,80/542		29,70/772		54,50/1417
400		24,00/625		33,70/875		62,50/1625
450		29,00/753		47,90/1245		81,70/2125
500		32,20/836		53,20/1382		90,70/2358
600		39,10/1017		64,30/1672		109,30/2843

KOMÍNOVÉ HLAVICE | KOMÍNOVÉ HLAVICE | FLUE TERMINATIONS | KAMINHAUBE | KÉMÉNY FEJ

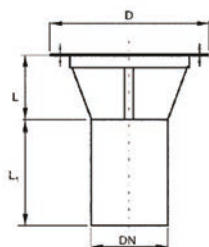

kód	AHM 6.41.13				
DN [mm]	L [mm]	L ₁ [mm]	D [mm]	€/Kč	
100	130	205	260	15,00/389	
113	130		260	15,00/389	
120	130		260	16,10/417	
130	130		260	16,80/438	
140	130		260	17,60/456	
150	130		260	18,30/476	
160	150		300	19,60/509	
180	150	300	20,90/544		
200	150	255	300	23,30/606	
225	200		500	25,80/672	
250	200		500	29,90/777	
300	200		700	38,80/1009	
355	200		700	42,00/1092	
400	250		700	60,60/1576	
450	250		800	66,40/1728	
500	250		900	79,90/2077	
600	300		900	84,20/2188	

INOX SRS

INOX SRS

komponenty INOX | components INOX | komponente | INOX elemek |
bez povrchovej úpravy | uncoated | unbeschichtet | bevonat nélkül
EN 1856 - T400 - N1 - W - V2 - L50060 - O(100) - L50100
EN 1856 - T400 - N1 - D - V3 - L50060 - G(300) - L50100



Komponenty dymovodov - INOX jednovrstvový systém Kaminodur SRS- teplotná trieda T400

KRYT S VODIACOU DILATAČNOU RÚROU | KRYT S VODÍCÍ DILATAČNÍ TRUBKOU | COVER WITH DILATATION PIPE | DILATATIONSROHR
ABDECKEN | FEDÉL DILATÁCIÓS CSŐVEL

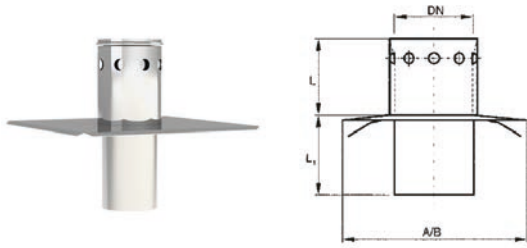

kód	AKM 6.50.63			
DN [mm]	L [mm]	L ₁ [mm]	A/B	€/Kč
100	150	150	350/350	21,50/559
113	150		350/350	21,60/562
120	150		350/350	22,50/585
130	150		350/350	23,30/607
140	150		350/350	24,30/631
150	150		350/350	26,00/675
160	200		350/350	29,60/770
180	200		530/530	32,20/837
200	200		530/530	34,80/905
225	280		175	530/530
250	280	530/530		48,00/1249
300	400	530/530		48,40/1259
355	400	530/530		48,90/1271
400	400	710/710		55,30/1438
450	450	710/710		98,60/2564
500	500	710/710		113,80/2959
600	600	850/850		162,60/4229

TELESKOPICKÝ POSUVNÝ DIEL | TELESKOPICKÝ POSUVNÝ DÍL | TELESCOPIC SLIDE | TELESKOPSCHLITTEN | TELESZKÓPOS CSŐ

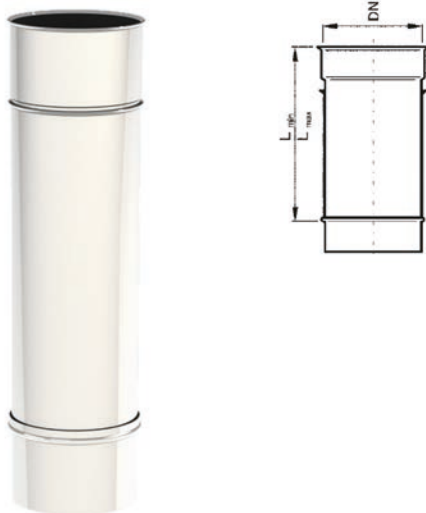

kód	TKM 1.15.03		
DN [mm]	L _{min} [mm]	L _{max} [mm]	€/Kč
100	345	530	26,40/596
113			27,10/704
120			27,80/722
130			29,30/762
140			30,90/803
150			31,90/830
160			34,10/887
180			37,10/965
200			40,40/1051
225			44,50/1157
250			47,40/1231
300			59,40/1544
355			77,70/2021
400			81,70/2125
450			89,80/2335
500			100,30/2607
600	126,20/3281		

INOX SRS

INOX SRS

komponenty INOX | components INOX | komponente | INOX elemek
 bez povrchovej úpravy | uncoated | unbeschichtet | bevonat nélkül
 EN 1856 - T400 - N1 - W - V2 - L50060 - O(100) - L50100
 EN 1856 - T400 - N1 - D - V3 - L50060 - G(300) - L50100



Komponenty dymovodov - INOX jednovrstvový systém Kaminodur SRS- teplotná trieda T400

TLMIČ HLUKU SPALÍN | TLUMIČ HLUKU SPALIN | FLUE GAS SILENCER | ABGASSCHALLDÄMPFER | FÜSTGÁZ-HANGTOMPÍTÓ

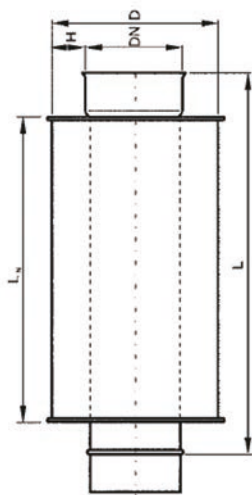

kód		SAM 1.13.03				
DN [mm]	L _N [mm]=500L	L _N [mm]=750L	L _N [mm]=1000L	H=50 D	L=100 D	€/Kč
100	645	895	1145	202	302	204,20/5308
113				215	315	224,70/5842
120				222	322	228,20/5949
130				232	332	234,40/6092
140				242	342	254,50/6616
150				252	352	259,90/6757
160				262	362	264,90/6888
180				282	382	292,70/7611
200				302	402	315,00/8191
225				327	427	337,00/8762
250				352	452	374,80/9745
300				1475	402	502

ZAÚŠŤOVACÍ DIEL 90° | ZAÚŠŤOVACÍ DÍL 90° | FITTING 90° | SCHORNSTEINMONTAGE 90° | 90° T-IDOM

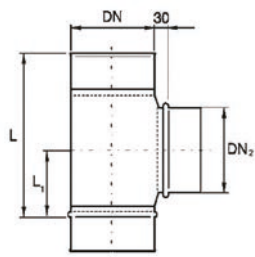

kód		ATM 3.13.90			
DN [mm]	DN ₂ [mm]	L [mm]	L ₁ [mm]	€/Kč	
300	300	505	245	60,30/1567	
	200	405	195	60,30/1567	
	225	430	205	60,30/1567	
	250	455	220	60,30/1567	
355	355	560	270	61,50/1600	
	250	455	220	61,50/1600	
	300	505	245	61,50/1600	
400	400	605	295	70,90/1843	
	300	505	245	70,90/1843	
	355	560	270	70,90/1843	
450	450	655	320	82,00/2131	
	300	505	245	82,00/2131	
	355	560	270	82,00/2131	
500	500	705	345	93,60/2433	
	355	560	270	93,60/2433	
	400	605	295	93,60/2433	
600	450	655	320	93,60/2433	
	600	805	395	113,40/2948	
	400	605	295	113,40/2948	
600	450	655	320	113,40/2948	
	500	705	345	113,40/2948	

kód ATM 3.13.90					kód ATM 3.13.90				
DN [mm]	DN ₂ [mm]	L [mm]	L ₁ [mm]	€/Kč	DN [mm]	DN ₂ [mm]	L [mm]	L ₁ [mm]	€/Kč
100	100	265	125	22,90/596	160	160	345	155	33,10/860
	100	265	125	22,90/596		130	315	140	33,10/860
113	113	300	135	23,70/615	180	140	335	150	33,10/860
	100	265	125	23,70/615		150	335	150	33,10/860
120	120	305	135	25,40/660	200	180	385	185	38,00/989
	100	265	125	25,40/660		150	335	150	38,00/989
	113	300	135	25,40/660		160	345	155	38,00/989
130	130	315	140	26,60/692	225	200	405	195	40,80/1061
	113	300	135	26,60/692		150	335	150	40,80/1061
	120	305	135	26,60/692		160	345	155	40,80/1061
140	140	335	150	28,80/750	250	180	385	185	40,80/1061
	113	300	135	28,80/750		225	430	205	46,60/1211
	120	305	135	28,80/750		180	385	185	46,60/1211
150	130	315	140	28,80/750	250	200	405	195	46,60/1211
	150	335	150	31,20/812		250	455	220	54,50/1418
	130	315	140	31,20/812		200	405	195	54,50/1418
	140	335	150	31,20/812		225	430	205	54,50/1418

INOX SRS

INOX SRS

komponenty INOX | components INOX | komponente | INOX elemek |
bez povrchovej úpravy | uncoated | unbeschichtet | bevonat nélkül
EN 1856 - T400 - N1 - W - V2 - L50060 - O(100) - L50100
EN 1856 - T400 - N1 - D - V3 - L50060 - G(300) - L50100



Komponenty dymovodov - INOX jednovrstvový systém Kaminodur SRS- teplotná trieda T400

ZAÚŠŤOVACÍ DÍL 45° | ZAÚŠŤOVACÍ DÍL 45° | FITTING 45° | SCHORNSTEINMONTAGE 45° | 45° T-IDOM

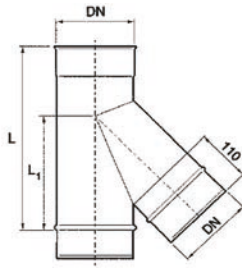

kód	ATM 3.10.45		
DN [mm]	L [mm]	L ₁ [mm]	€/Kč
100	300	175	22,70/590
113	320	195	25,20/655
120	330	200	26,60/691
130	340	210	28,60/743
140	350	225	30,70/798
150	370	235	33,00/859
160	410	260	36,30/945
180	440	285	41,20/1071
200	470	310	46,50/1209
225	500	338	53,20/1383
250	540	370	61,10/1590
300	640	445	80,00/2079
355	740	520	92,70/2410
400	860	605	116,20/3021
450	930	665	139,00/3614
500	1010	730	164,90/4288
600	1090	795	222,40/5781

ZBERAČ KONDENZÁTU | SBĚRAČ KONDENZÁTU | CONDENSATE COLLECTOR | KONDENSATSAMMLER | KONDENZÁTUMGYŰJTŐ

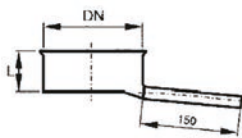

kód	KOM 6.31.13	
DN [mm]	L [mm]	€/Kč
100	75	18,60/484
113		19,10/498
120		19,50/506
130		19,90/518
140		20,30/529
150		20,80/541
160		21,50/558
180		22,40/582
200		23,30/606
225		24,50/636
250		25,80/670
300		29,00/754
355		28,40/739
400		31,80/828
450		35,90/934
500		40,30/1049
600	57,40/1492	

INOX SRS

komponenty INOX | components INOX | komponente | INOX elemek
 bez povrchovej úpravy | uncoated | unbeschichtet | bevonat nélkül
 EN 1856 - T400 - N1 - W - V2 - L50060 - O(100) - L50100
 EN 1856 - T400 - N1 - D - V3 - L50060 - G(300) - L50100



Komponenty dymovodov - INOX jednovrstvový systém Kaminodur SRS- teplotná trieda T400

REGULÁTOR ŤAHU | REGULÁTOR TAHU | THRUST REGULATOR | SCHUBREGLER | HUZAT SZABÁLYOZÓ

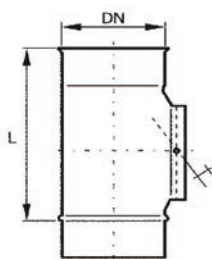

kód		KOM 6.31.13
DN [mm]	L [mm]	€/Kč
100	335	74,10/1927
113		76,10/1979
120		77,30/2009
130		78,90/2052
140		80,60/2097
150		81,30/2114
160		82,00/2133
180		86,80/2257
200		91,40/2376
225		97,30/2531
250	103,70/2696	
300	355	116,20/3021
355		131,40/3416
400		145,90/3794
450		162,90/4235
500		180,80/4701
600		212,30/5519

PREDLŽOVACÍ NÁSTAVEC PRE KONTROLNÝ OTVOR | PRODLUŽOVACÍ NÁSTAVEC PRO KONTROLNÍ OTVOR | EXTENSION NOZZLE FOR INSPECTION HOLE | VERLÄNGERUNGSLÖCH FÜR DAS KONTROLLLOCH | ELLENŐRZŐ NYÍLÁS HOSSZABBÍTÓ

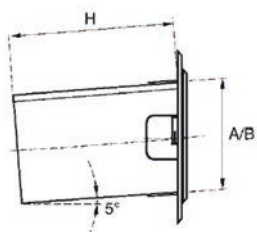

kód			SVM 6.29.20			kód			SVM 6.29.10		
A/B [mm]	H [mm]	€/Kč	A/B [mm]	H [mm]	€/Kč	A/B [mm]	H [mm]	€/Kč	A/B [mm]	H [mm]	€/Kč
120/180	265	36,40/947	120/180	132	31,80/826						
kód			SVM 6.29.22			kód			SVM 6.29.12		
A/B [mm]	H [mm]	€/Kč	A/B [mm]	H [mm]	€/Kč	A/B [mm]	H [mm]	€/Kč	A/B [mm]	H [mm]	€/Kč
150/300	265	53,30/1387	150/300	132	46,40/1027						

KOMÍNOVÉ DVIERKA | KOMÍNOVÁ DVÍRKA | CHIMNEY DOOR | KAMINTÜR | KÉMÉNY AJTAJA

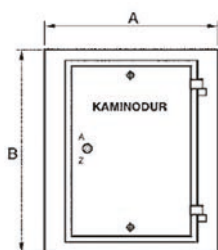

kód		SOT 6.60.03
A [mm]	B [mm]	€/Kč
120	180	20,30/527
kód		SOT 6.60.23
A [mm]	B [mm]	€/Kč
150	300	31,10/809

INOX SRS

INOX SRS

komponenty INOX | components INOX | komponente | INOX elemek |
 bez povrchovej úpravy | uncoated | unbeschichtet | bevonat nélkül
 EN 1856 - T400 - N1 - W - V2 - L50060 - O(100) - L50100
 EN 1856 - T400 - N1 - D - V3 - L50060 - G(300) - L50100



Komponenty dymovodov - INOX jednovrstvový systém Kaminodur SRS- teplotná trieda T400

TVAROVKA PRE KONTROLNÝ OTVOR | TVAROVKA PRO KONTROLNÍ OTVOR | FITTING FOR INSPECTION HOLE | PASSEND FÜR DAS
 INSPEKTIONSLOCH | EGYENES IDOM ELLENŐRZŐ NYÍLÁSSAL

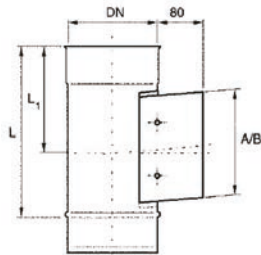

kód	REM 6.25.10			REM 6.25.12		
	A/B = 120/180			A/B = 150/300		
	L [mm]	L ₁ [mm]	€/Kč	L [mm]	L ₁ [mm]	€/Kč
100	290	180	22,50/585	410	230	
113			23,40/608			
120			23,90/620			
130			24,80/645			
140			25,30/657			
150			26,00/675			38,30/995
160			26,90/700			38,80/1008
180			28,20/734			39,90/1036
200			29,60/770			40,90/1062
225			31,30/814			41,90/1088
250			33,10/860			44,20/1149
300			36,50/950			48,40/1260
355			40,30/1047			50,60/1314
400			43,50/1131			54,70/1423
450			47,10/1225			59,40/1543
500			51,20/1331			64,30/1671
600			61,50/1600			74,50/1936

OTOČNÉ KOLENO 0-90° S KONTROLNÝM OTVOROM | OTOČNÉ KOLENO 0-90° S KONTROLNÍM OTVOREM | SWIVEL ELBOW 0-90° WITH INSPEC-
 TION HOLE | SCHWENKBOGEN 0-90° MIT REVISIONSÖFFNUNG | ÁLLÍTHATÓ KÖNYÖK 0-90° ELLENŐRZŐ NYÍLÁSSAL

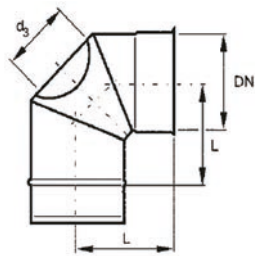

kód	BOM 2.20.13		
	DN [mm]	L [mm]	d ₃ [mm]
100	150	80	25,40/662
113	155	80	27,30/711
120	160	80	27,80/724
130	165	80	28,50/741
140	170	80	30,60/795
150	175	100	34,70/903
160	180	100	41,00/1065
180	190	100	46,50/1208
200	200	100	49,30/1283
225	215	100	55,30/1438
250	225	150	57,70/1500

INOX SRS

INOX SRS

komponenty INOX | components INOX | komponente | INOX elemek
 bez povrchovej úpravy | uncoated | unbeschichtet | bevonat nélkül
 EN 1856 - T400 - N1 - W - V2 - L50060 - O(100) - L50100
 EN 1856 - T400 - N1 - D - V3 - L50060 - G(300) - L50100



Komponenty dymovodov - INOX jednovrstvový systém Kaminodur SRS- teplotná trieda T400

OTOČNÉ KOLENO 0-45° | OTOČNÉ KOLENO 0-45° | SWIVEL ELBOW 0-45° | SCHWENKBOGEN 0-45° | ÁLLÍHATÓ KÖNYÖK 0-45°

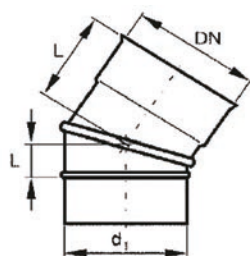

kód		BOM 2.20.13	
DN [mm]	L [mm]	€/Kč	
100	95	25,40	662
113	100	27,30	711
120	100	27,80	724
130	100	28,50	741
140	105	30,60	795
150	105	34,70	903
160	110	41,00	1065
180	110	46,50	1208
200	115	49,30	1283
225	120	55,30	1438
250	125	57,70	1500

KOLENÁ | KOLENÁ | ELBOW | BOGEN | KÖNYÖKÖK

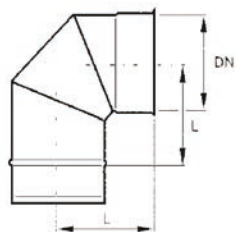

kód		BSM 2.11.90	
α	90°		
DN [mm]	L [mm]	€/Kč	
100	135	14,90	386
113	140	16,00	417
120	145	16,70	433
130	150	17,60	458
140	155	18,50	481
150	160	19,50	506
160	165	20,30	529
180	175	22,20	577
200	185	24,00	624
225	200	29,10	756
250	210	34,00	883
300	235	44,00	1145
355	265	51,50	1340
400	285	59,10	1537
450	310	69,30	1803
500	335	80,30	2088
600	385	101,40	2638

INOX SRS

INOX SRS

komponenty INOX | components INOX | komponente | INOX elemek |
 bez povrchovej úpravy | uncoated | unbeschichtet | bevonat nélkül
 EN 1856 - T400 - N1 - W - V2 - L50060 - O(100) - L50100
 EN 1856 - T400 - N1 - D - V3 - L50060 - G(300) - L50100



Komponenty dymovodov - INOX jednovrstvový systém Kaminodur SRS- teplotná trieda T400

KOLENÁ | KOLENÁ | ELBOW | BOGEN | KÖNYÖKÖK

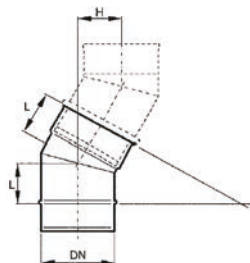
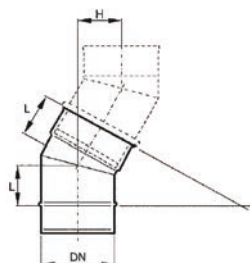
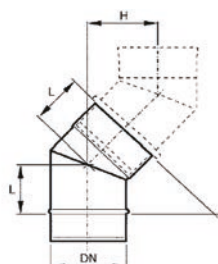
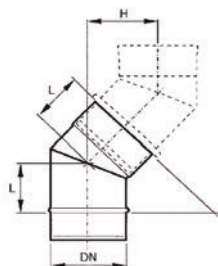

kód	BSM 2.11.60			BSM 2.11.45		
α	60°			45°		
DN [mm]	L [mm]	H [mm]	€/Kč	L [mm]	H [mm]	€/Kč
100	110	190	14,90/386	90	130	12,20/317
113	115	200	16,00/417	95	135	12,90/334
120	115	200	16,70/433	95	135	13,20/344
130	120	210	17,60/458	100	145	13,80/358
140	120	210	18,50/481	100	145	14,30/372
150	125	220	19,50/506	100	145	14,80/384
160	125	220	20,30/529	105	150	15,30/398
180	130	225	22,20/577	110	155	16,40/427
200	140	245	24,00/624	115	165	17,50/455
225	145	250	29,10/756	120	170	22,30/580
250	155	270	34,00/883	125	180	25,30/657
300	170	295	44,00/1145	135	190	31,60/822
355	185	320	51,50/1340	145	205	34,40/895
400	195	340	59,10/1537	155	220	39,50/1028
450	210	365	69,30/1803	165	235	45,30/1178
500	225	390	80,30/2088	175	250	51,90/1348
600	255	445	101,40/2638	195	275	63,70/1657

kód	BSM 2.11.30			BSM 2.11.15		
α	30°			15°		
DN [mm]	L [mm]	H [mm]	€/Kč	L [mm]	H [mm]	€/Kč
100	85	85	11,60/301	70	40	11,30/294
113	85	85	12,20/318	70	40	11,90/310
120	90	90	12,50/326	70	40	12,20/318
130	90	90	13,10/341	80	40	12,70/331
140	90	90	13,60/355	80	40	13,20/343
150	90	90	14,10/366	80	40	13,60/355
160	90	90	14,60/380	80	40	14,10/366
180	95	95	15,70/408	100	50	15,10/393
200	100	100	16,70/434	100	55	16,10/418
225	100	100	20,50/532	100	55	17,60/458
250	105	105	23,00/598	100	55	24,20/629
300	110	110	28,20/732	110	60	24,60/640
355	120	120	31,40/817	110	60	28,40/739
400	125	125	35,50/923	110	60	32,10/835
450	135	135	40,10/1044	125	65	35,60/926
500	140	140	45,90/1195	125	65	40,00/1041
600	150	150	54,80/1426	125	65	46,50/1210

INOX SRS

INOX SRS

komponenty INOX | components INOX | komponente | INOX elemek
 bez povrchovej úpravy | uncoated | unbeschichtet | bevonat nélkül
 EN 1856 - T400 - N1 - W - V2 - L50060 - O(100) - L50100
 EN 1856 - T400 - N1 - D - V3 - L50060 - G(300) - L50100



Komponenty dymovodov - INOX jednovrstvový systém Kaminodur SRS- teplotná trieda T400

KOLENO 0-90° S KONTROLNÝM OTVOROM | KOLENO 0-90° S KONTROLNÍM OTVOREM | ELBOW 0-90° WITH INSPECTION HOLE | BOGEN
 0-90° MIT REVISIONSÖFFNUNG | KÖNYÖK 0-90° ELLENŐRZŐ NYÍLÁSSAL

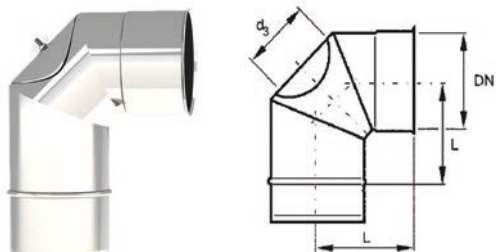

kód	BPM 2.30.90		
DN [mm]	L [mm]	d ₃ [mm]	€/Kč
100	135	80	23,30/607
113	140	80	23,90/621
120	145	80	25,00/649
130	150	80	25,80/671
140	155	80	26,60/692
150	160	100	27,80/724
160	165	100	29,40/765
180	175	100	33,50/871
200	185	100	38,70/1007
225	200	100	43,30/1126
250	210	150	50,30/1309
300	235	150	55,90/1452
355	265	150	64,90/1688
400	285	150	72,80/1892
450	310	150	82,30/2139
500	335	150	92,80/2413
600	385	150	117,90/3065

OBJÍMKA | OBJÍMKA | SLEEVE | BUCHSE | BILINCS

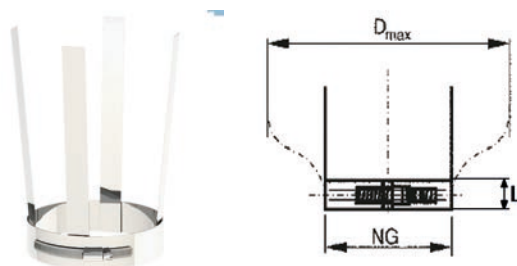

kód	HAL 9.10.13	
NG [mm]	L [mm]	€/Kč
100	30	5,70/147
113	30	5,70/147
120	30	5,80/150
130	30	5,90/153
140	30	6,20/162
150	30	6,50/169
160	30	6,90/179
180	30	6,90/179
200	30	7,00/183
225	30	7,10/185
250	30	7,20/187
300	30	7,30/191
355	30	7,60/198
400	30	7,90/205
450	30	8,10/210
500	30	8,30/215
600	30	8,80/228

INOX SRS

INOX SRS

komponenty INOX | components INOX | komponente | INOX elemek |
bez povrchovej úpravy | uncoated | unbeschichtet | bevonat nélkül
EN 1856 - T400 - N1 - W - V2 - L50060 - O(100) - L50100
EN 1856 - T400 - N1 - D - V3 - L50060 - G(300) - L50100



Komponenty dymovodov - INOX jednovrstvový systém Kaminodur SRS- teplotná trieda T400

OBJÍMKA | OBJÍMKA | SLEEVE | MANSCHETTE | BILINCS

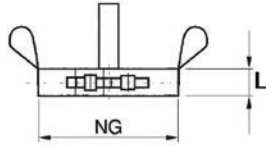

kód	HAL 9.10.14	
NG [mm]	L [mm]	€/Kč
100	30	7,20/187
113	30	7,20/187
120	30	7,30/189
130	30	7,40/192
140	30	7,40/192
150	30	7,50/197
160	30	7,50/197
180	30	7,60/198
200	30	7,80/202
225	30	7,90/205
250	30	7,90/205
300	30	8,10/210
355	30	8,20/214
400	30	8,40/218
450	30	8,60/224
500	30	8,90/232
600	30	9,40/244

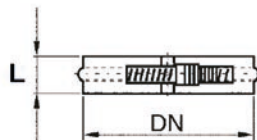

kód	SSM 5.75.03	
DN [mm]	L [mm]	€/Kč
100	30	4,90/128
113	30	4,90/128
120	30	4,90/129
130	30	5,00/129
140	30	5,00/129
150	30	5,10/133
160	30	5,10/133
180	30	5,20/136
200	30	5,30/138
225	30	5,40/141
250	30	5,50/143
300	30	5,70/148
355	30	5,90/154
400	30	6,10/160
450	30	6,40/167
500	30	6,70/174
600	30	7,10/185

INOX SRS

INOX SRS

komponenty INOX | components INOX | komponente | INOX elemek
bez povrchovej úpravy | uncoated | unbeschichtet | bevonat nélkül
EN 1856 - T400 - N1 - W - V2 - L50060 - O(100) - L50100
EN 1856 - T400 - N1 - D - V3 - L50060 - G(300) - L50100



Komponenty dymovodov - INOX jednovrstvový systém Kaminodur SRS- teplotná trieda T400

REDUKCIE | REDUKCE | REDUCER | REDUKTION | BÖVITŐK

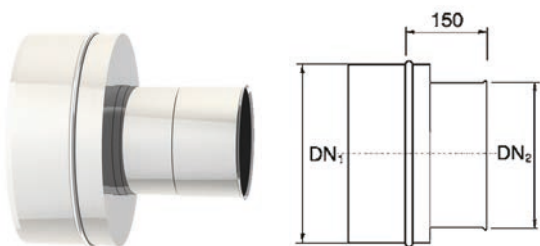

kód	USM 4.19.03	
DN ₁ [mm]	DN ₂ [mm]	€/Kč
100	DN ₁ >DN ₂	
113	DN ₁ >DN ₂	15,90/413
120	DN ₁ >DN ₂	16,40/427
130	DN ₁ >DN ₂	17,40/453
140	DN ₁ >DN ₂	17,70/460
150	DN ₁ >DN ₂	18,70/487
160	DN ₁ >DN ₂	19,40/503
180	DN ₁ >DN ₂	20,50/532
200	DN ₁ >DN ₂	21,80/567
225	DN ₁ >DN ₂	23,50/611
250	DN ₁ >DN ₂	25,30/658
300	DN ₁ >DN ₂	28,70/745
355	DN ₁ >DN ₂	33,00/859
400	DN ₁ >DN ₂	37,20/966
450	DN ₁ >DN ₂	41,80/1087
500	DN ₁ >DN ₂	46,80/1218
600	DN ₁ >DN ₂	56,30/1464

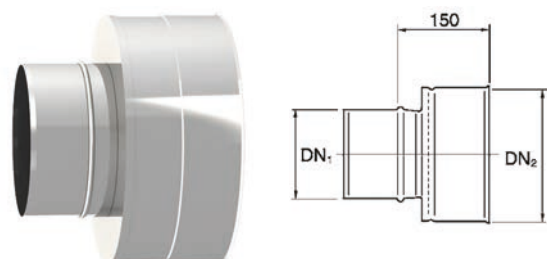

kód	USM 4.20.03	
DN ₂ [mm]	DN ₁ [mm]	€/Kč
100	DN ₁ <DN ₂	17,10/444
113	DN ₁ <DN ₂	17,70/460
120	DN ₁ <DN ₂	18,80/488
130	DN ₁ <DN ₂	19,10/496
140	DN ₁ <DN ₂	20,20/525
150	DN ₁ <DN ₂	20,90/544
160	DN ₁ <DN ₂	22,20/578
180	DN ₁ <DN ₂	23,80/619
200	DN ₁ <DN ₂	25,70/668
225	DN ₁ <DN ₂	27,80/723
250	DN ₁ <DN ₂	31,60/821
300	DN ₁ <DN ₂	36,40/947
355	DN ₁ <DN ₂	41,00/1067
400	DN ₁ <DN ₂	46,10/1199
450	DN ₁ <DN ₂	51,60/1342
500	DN ₁ <DN ₂	61,90/1609
600	DN ₁ <DN ₂	61,90/1609

INOX SRS

INOX SRS

komponenty INOX | components INOX | komponente | INOX elemek |
 bez povrchovej úpravy | uncoated | unbeschichtet | bevonat nélkül
 EN 1856 - T400 - N1 - W - V2 - L50060 - O(100) - L50100
 EN 1856 - T400 - N1 - D - V3 - L50060 - G(300) - L50100



Komponenty dymovodov - INOX jednovrstvový systém Kaminodur SRS- teplotná trieda T400

PŘÍPOJKA SPOTREBIČA | PŘÍPOJKA SPOTŘEBIČE | APPLIANCE CONNECTION | GERÄTEANSCHLUSS | KÉSZÜLÉK CSATLAKOZTATÁSA

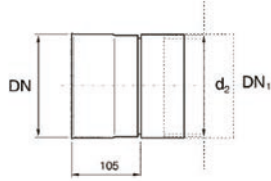
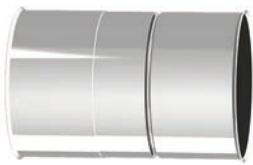

pre montáž nasunutím

d2 - požadovaný vnútorný priemer prípojky spotrebiča špecifikovať v objednávke.

Poznámka:

Vnútorný priemer prípojky spotrebiča je spravidla o 1 mm väčší od vonkajšieho priemeru pripojovacieho nástavca spotrebiča.

kód	KAM 4.13.23					€/Kč
DN [mm]	DN ₁ =DN	DN<DN ₁		DN>DN ₁		
100	100	113	120			8,30/215
113	113	120	130	100		8,80/229
120	120	130	140	113	100	9,10/236
130	130	140	150	120	113	9,50/247
140	140	150	160	130	120	9,90/258
150	150	160	180	140	130	10,30/268
160	160	180	200	150	140	10,70/278
180	180	200	225	160	150	11,50/298
200	200	225	250	180	160	12,30/319
225	225	250	300	200	180	13,30/345
250	250	300	355	225	200	14,30/372
300	300	355	400	250	225	16,20/422
355	355	400	450	300	250	18,40/477
400	400	450	500	355	300	20,30/527
450	450	500	600	400	355	22,40/582
500	500	600		450	400	24,50/638
600	600			500	450	28,50/740

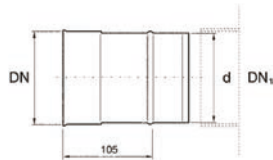
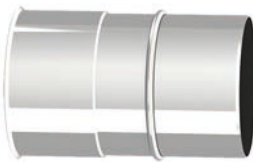

pre montáž zasunutím

d - požadovaný vonkajší priemer prípojky spotrebiča špecifikovať v objednávke.

Poznámka:

Vonkajší priemer prípojky spotrebiča je spravidla o 1mm menší od vnútorného priemeru pripojovacieho nástavca spotrebiča.

kód	KAM 4.13.33					€/Kč
DN [mm]	DN ₁ =DN	DN<DN ₁		DN>DN ₁		
100	100	113	120			8,30/215
113	113	120	130	100		8,80/229
120	120	130	140	113	100	9,10/236
130	130	140	150	120	113	9,50/247
140	140	150	160	130	120	9,90/258
150	150	160	180	140	130	10,30/268
160	160	180	200	150	140	10,70/278
180	180	200	225	160	150	11,50/298
200	200	225	250	180	160	12,30/319
225	225	250	300	200	180	13,30/345
250	250	300	355	225	200	14,30/372
300	300	355	400	250	225	16,20/422
355	355	400	450	300	250	18,40/477
400	400	450	500	355	300	20,30/527
450	450	500	600	400	355	22,40/582
500	500	600		450	400	24,50/638
600	600			500	450	28,50/740

INOX SRS

INOX AGS

komponenty INOX | components INOX | komponente | INOX elemek
 bez povrchovej úpravy | uncoated | unbeschichtet | bevonat nélkül
 EN 1856 - T200 - P1 - W - V2 - L50060 - O(100) - L50100



Komponenty dymovodov - INOX jednovrstvový pretlakový systém Kaminodur AGS teplotná trieda T200



UKONČOVACIA RÚRA | UKONČOVACÍ TRUBKA | END PIPE | FINISHING ROHR | VÉGSŐ CSŐ

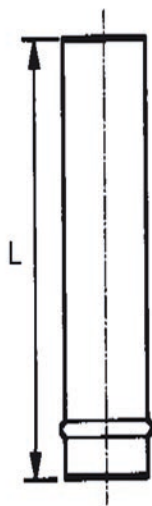

typ spoja	kód	ROK/ROS 1.12.13	
	DN [mm]	L [mm]	€/Kč
K	80	1000	18,50/481
	100		18,50/481
	113		19,20/499
	130		20,80/541
	150		22,70/589
S	180		27,00/702
	200		29,80/774
	225		34,70/903
	250		37,10/965
	300		44,80/1165
	355		54,50/1417
	400		62,50/1625
	500		95,20/2474
600	116,70/3033		

DĚLKOVÝ DÍL S VÝVODEM NA MĚŘENÍ | DÉLKOVÝ DÍL S VÝVODEM PRO MĚŘENÍ | LENGTH PIECE WITH OUTLET FOR MEASUREMENT |
 LÄNGENSTÜCK MIT AUSLASS ZUR MESSUNG | CSŐ MÉRŐLYUKKAL

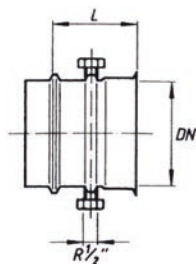

typ spoja	kód	ROK/ROS 1.18.13	
	DN [mm]	L [mm]	€/Kč
K	80	250	18,60/482
	100		19,70/512
	113		20,10/523
	130		20,20/525
	150		20,60/535
S	180		24,40/633
	200		26,10/677
	225		28,70/745
	250		30,10/782
	300		32,70/850
	355		36,70/954
	400		41,60/1080
	500		47,70/1240
600	50,40/1311		

INOX AGS

INOX AGS

komponenty INOX | components INOX | komponente | INOX elemek
 bez povrchovej úpravy | uncoated | unbeschichtet | bevonat nélkül
 EN 1856 - T200 - P1 - W - V2 - L50060 - O(100) - L50100



Komponenty dymovodov - INOX jednovrstvový pretlakový systém Kaminodur AGS teplotná trieda T200

TELESKOPICKÝ POSUVNÝ DIEL | TELESKOPICKÝ POSUVNÝ DÍL | TELESCOPIC SLIDE | TELESKOPSCHLITTEN | TELESZKÓPOS CSŐ

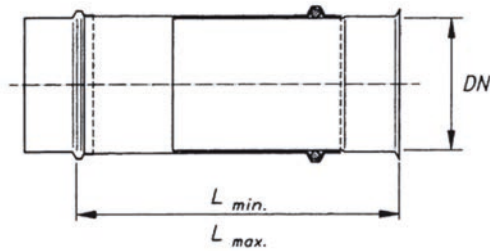

typ spoja	kód	TKK/TKS 1.15.03		€/Kč
		DN [mm]	L min.	
K	80	375	530	33,20/863
	100			32,60/848
	113			33,80/878
	130			36,60/951
	150			41,10/1070
S	180			47,70/1241
	200			52,20/1357
	225			58,60/1523
	250			62,90/1637
	300			70,70/1837
	355			80,90/2103
	400			94,70/2462
	500			110,10/2862
	600			133,70/3477

UHLOVÝ DIEL 87° S KONTROLNÝM OTVOROM | ÚHLOVÝ DÍL 87° S KONTROLNÍM OTVOREM | ANGULAR PIECE 87° WITH INSPECTION HOLE | ECKIGES STÜCK 87° MIT REVISIONSÖFFNUNG | 87°- OS IDEM ELLENŐRZŐ NYÍLÁSSAL

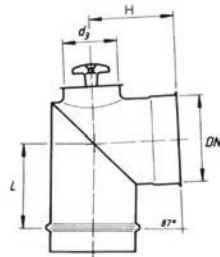

typ spoja	kód	WPK/WPS 2.21.87			€/Kč
		DN [mm]	L [mm]	H [mm]	
K	80	85	135	80	27,20/706
	100	95	145	100	30,50/794
	113	80	155	113	31,80/827
	130	90	160	130	34,80/905
	150	90	170	150	38,40/998
S	180	185	185	150	56,10/1458
	200	195	195	150	59,20/1540
	225	210	210	150	63,50/1651
	250	220	220	150	67,70/1759
	300	245	245	150	76,60/1992
	355	275	275	150	87,70/2280
	400	295	295	150	97,50/2535
	500	345	345	150	122,30/3179
600	395	395	150	146,20/3801	

INOX AGS

INOX AGS

komponenty INOX | components INOX | komponente | INOX elemek
 bez povrchovej úpravy | uncoated | unbeschichtet | bevonat nélkül
 EN 1856 - T200 - P1 - W - V2 - L50060 - O(100) - L50100



Komponenty dymovodov - INOX jednovrstvový pretlakový systém Kaminodur AGS teplotná trieda T200

UHLOVÝ DIEL 87° S KONTROLNÝM OTVOROM | ÚHLOVÝ DÍL 87° S KONTROLNÍM OTVOREM | ANGULAR PIECE 87° WITH INSPECTION
 HOLE | ECKIGES STÜCK 87° MIT REVISIONSÖFFNUNG | 87°- OS IDEM ELLENŐRZŐ NYÍLÁSSAL

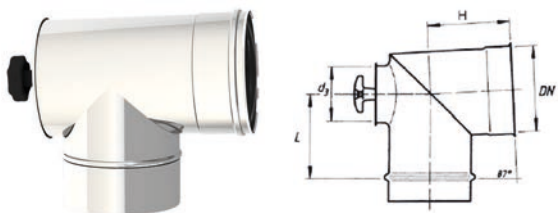

typ spoja	kód	WPK/WPS 2.22.87			€/Kč
		DN [mm]	L [mm]	H [mm]	
K	80	85	135	80	27,20/706
	100	95	145	100	30,50/794
	113	80	155	113	31,80/827
	130	90	160	130	34,80/905
	150	90	170	150	38,40/998
S	180	185	185	150	56,10/1458
	200	195	195	150	59,20/1540
	225	210	210	150	63,50/1651
	250	220	220	150	67,70/1759
	300	245	245	150	76,60/1992
	355	275	275	150	87,70/2280
	400	295	295	150	97,50/2535
	500	345	345	150	122,30/3179
600	395	395	150	146,20/3801	

KOLENO 90° S KONTROLNÝM OTVOROM | KOLENO 90° S KONTROLNÍM OTVOREM | ELBOW 90° WITH INSPECTION HOLE | BOGEN 90° MIT
 REVISIONSÖFFNUNG | 90°- OS KÖNYÖK ELLENŐRZŐ NYÍLÁSSAL

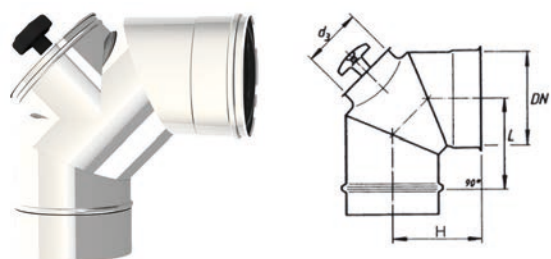

typ spoja	kód	BPK/BPS 2.30.90			€/Kč
		DN [mm]	L [mm]	H [mm]	
K	80	125	165	80	27,40/713
	100	150	190	100	33,50/871
	113	100	195	113	36,00/936
	130	105	205	130	38,80/1008
	150	115	215	150	40,30/1047
S	180	230	230	150	41,90/1089
	200	240	240	150	43,10/1121
	225	250	250	150	46,70/1215
	250	240	240	150	47,90/1245
	300	250	250	150	54,20/1410
	355	290	290	150	61,00/1586
	400	320	320	150	68,90/1791
	500	350	350	150	84,30/2191
600	400	400	150	103,60/2694	

INOX AGS

INOX AGS

komponenty INOX | components INOX | komponente | INOX elemek
 bez povrchovej úpravy | uncoated | unbeschichtet | bevonat nélkül
 EN 1856 - T200 - P1 - W - V2 - L50060 - O(100) - L50100



Komponenty dymovodov - INOX jednovrstvový pretlakový systém Kaminodur AGS teplotná trieda T200

KOLENO 87° S KONTROLNÝM OTVOROM | KOLENO 87° S KONTROLNÍM OTVOREM | ELBOW 87° WITH INSPECTION HOLE | BOGEN 87° MIT REVISIONSÖFFNUNG | 87°- OS KÖNYÖK ELLENŐRZŐ NYÍLÁSSAL

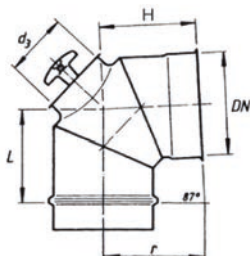

typ spoja	kód	BPK/BPS 2.30.87			€/Kč
		DN [mm]	L [mm]	H [mm]	
K	80	125	165	80	27,40/713
	100	150	190	100	33,50/871
	113	100	195	113	36,00/936
	130	105	205	130	38,80/1008
	150	115	215	150	40,30/1047
S	180	230	230	150	41,90/1089
	200	240	240	150	43,10/1121
	225	250	250	150	46,70/1215
	250	240	240	150	47,90/1245
	300	250	250	150	54,20/1410
	355	290	290	150	61,00/1586
	400	320	320	150	68,90/1791
	500	350	350	150	84,30/2191
600	400	400	150	103,60/2694	

ZAÚŠŤOVACÍ DIEL 87° S UPEVŇOVACÍM NÁSTAVCOM | ZAÚŠŤOVACÍ DÍL 87° S UPEVŇOVACÍM NÁSTAVCEM | PLUG-IN PIECE 87° WITH MOUNTING ATTACHMENT | EINSTECKSTÜCK 87° MIT BEFESTIGUNGSBEFESTIGUNG | 87° TALPAS KÖNYÖK

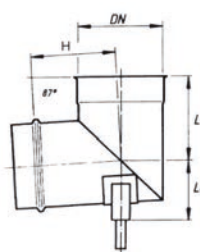

typ spoja	kód	ESK/ESS 2.40.87				€/Kč
		DN [mm]	L [mm]	H [mm]	L ₁ [mm]	
K	80	100	60	95	22,40/582	
	100	110	70	105	24,10/628	
	113	135	75	110	29,20/759	
	130	145	85	120	32,00/833	
	150	155	95	130	35,30/917	
S	180	185	185	145	51,50/1340	
	200	195	195	155	56,20/1461	
	225	210	210	165	62,80/1632	
	250	220	220	180	69,00/1794	
	300	245	245	205	86,80/2257	
	355	275	275	230	104,40/2715	
	400	295	295	255	124,30/3233	
	500	345	345	305	163,90/4261	
600	395	395	355	212,50/5524		

INOX AGS

INOX AGS

komponenty INOX | components INOX | komponente | INOX elemek
 bez povrchovej úpravy | uncoated | unbeschichtet | bevonat nélkül
 EN 1856 - T200 - P1 - W - V2 - L50060 - O(100) - L50100



Komponenty dymovodov - INOX jednovrstvový pretlakový systém Kaminodur AGS teplotná trieda T200

ZAÚŠŤOVACÍ DIEL 87° S UPEVŇOVACÍM NÁSTAVCOM A KONTROLNÝM OTVOROM | ZAÚŠŤOVACÍ DÍL 87° S UPEVŇOVACÍM NÁSTAVCEM A KONTROLNÍM OTVOREM | PLUG-IN PIECE 87° WITH MOUNTING ATTACHMENT AND INSPECTION HOLE | EINSTECKSTÜCK 87° MIT BEFESTIGUNGSBEFESTIGUNG UND REVISIONSÖFFNUNG | 87° TALPAS KÖNYÖK ELLENŐRZŐ NYÍLÁSSAL

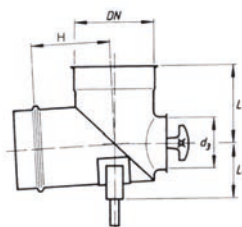

typ spoja	kód	EPK/EPS 2.41.87				€/Kč
		DN [mm]	L [mm]	H [mm]	L ₁ [mm]	
K	80	85	135	80	80	36,60/953
	100	95	145	100	100	39,10/1016
	113	80	155	113	113	46,10/1198
	130	90	160	130	130	50,40/1310
	150	90	170	150	150	55,50/1442
S	180	185	185	150	150	70,10/1824
	200	195	195	150	150	74,60/1940
	225	210	210	150	150	81,00/2106
	250	220	220	150	150	87,00/2262
	300	245	245	150	150	104,20/2709
	355	275	275	150	150	121,40/3157
	400	295	295	150	150	140,60/3657
	500	345	345	150	150	179,10/4656
600	395	395	150	150	227,20/5907	

ZAÚŠŤOVACÍ DIEL 87° | ZAÚŠŤOVACÍ DÍL 87° | PLUG-IN PIECE 87° | EINSTECKSTÜCK 87° | 87° T-IDOM

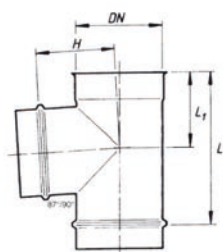

typ spoja	kód	ATK/ATS 3.13.87				€/Kč
		DN [mm]	L [mm]	L ₁ [mm]	H [mm]	
K	80	245	130	70	22,40/583	
	100	265	140	80	22,90/596	
	113	300	165	85	23,70/615	
	130	315	175	95	26,60/692	
	150	335	185	105	30,70/799	
S	180	385	185	185	38,70/1007	
	200	405	195	195	40,80/1061	
	225	430	205	205	46,60/1211	
	250	455	220	220	54,50/1418	
	300	505	245	245	66,90/1740	
	355	560	270	270	72,60/1888	
	400	605	295	295	100,60/2614	
	500	705	345	345	126,70/3295	
600	805	395	395	168,80/4388		

INOX AGS

INOX AGS

komponenty INOX | components INOX | komponente | INOX elemek
 bez povrchovej úpravy | uncoated | unbeschichtet | bevonat nélkül
 EN 1856 - T200 - P1 - W - V2 - L50060 - O(100) - L50100



Komponenty dymovodov - INOX jednovrstvový pretlakový systém Kaminodur AGS teplotná trieda T200

ZAÚŠŤOVACÍ DIEL 90° | ZAÚŠŤOVACÍ DÍL 90° | PLUG-IN PIECE 90° | EINSTECKSTÜCK 90° | 90° T-IDOM

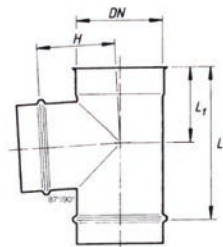

typ spoja	kód	ATK/ATS 3.13.90			€/Kč
		DN [mm]	L [mm]	L ₁ [mm]	
K	80	245	130	70	22,40/583
	100	265	140	80	22,90/596
	113	300	165	85	23,70/615
	130	315	175	95	26,60/692
	150	335	185	105	30,70/799
S	180	385	185	185	38,70/1007
	200	405	195	195	40,80/1061
	225	430	205	205	46,60/1211
	250	455	220	220	54,50/1418
	300	505	245	245	66,90/1740
	355	560	270	270	72,60/1888
	400	605	295	295	100,60/2614
	500	705	345	345	126,70/3295
600	805	395	395	168,80/4388	

OPORNÁ RÚRA S UPEVNŔOVACOU PLATŔOU | OPĚRNÁ TROUBA S UPEVNŔOVACÍ DESKOU | SUPPORT PIPE WITH MOUNTING PLATE |
 STÜTZROHR MIT MONTAGEPLATTE | TARTÓCSŐ RÖGZÍTŐLEMEZZEL

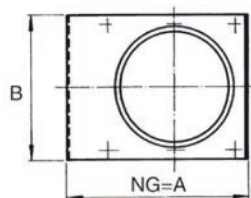
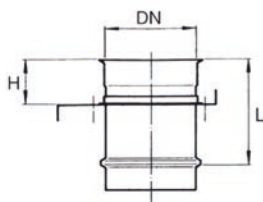

typ spoja	kód	SZS 9.21.03				€/Kč
		DN [mm]	L [mm]	H [mm]	NG=A	
K	80	170	85	210	170	14,80/385
	100	170	85	210	170	15,80/410
	113	170	85	210	170	16,80/436
	130	170	85	220	180	18,80/489
	150	170	85	245	205	21,60/561
S	180	210	105	265	225	33,50/871
	200	210	105	284	244	36,30/944
	225	210	105	304	264	40,10/1044
	250	210	105	334	294	43,70/1137
	300	240	120	356	316	54,30/1412
	355	240	120	404	364	63,30/1647
	400	240	120	456	416	71,60/1861
	500	240	120	604	564	90,90/2364
600	240	120	702	662	104,90/2726	

INOX AGS

INOX AGS

komponenty INOX | components INOX | komponente | INOX elemek
 bez povrchovej úpravy | uncoated | unbeschichtet | bevonat nélkül
 EN 1856 - T200 - P1 - W - V2 - L50060 - O(100) - L50100



Komponenty dymovodov - INOX jednovrstvový pretlakový systém Kaminodur AGS teplotná trieda T200



DILATAČNÁ RÚRA S UPEVŇOVACOU PLATŇOU | DILATAČNÍ TROUBA S UPEVŇOVACÍ DESKOU | EXPANSION PIPE WITH MOUNTING PLATE |
 EXPANSIONSROHR MIT MONTAGEPLATTE | DILATÁCIÓS CSŐ RÖGZÍTŐ LEMEZZEL

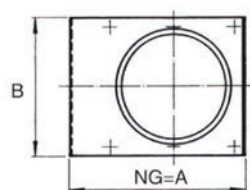
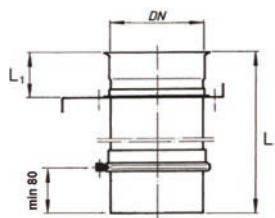

typ spoja	kód	SZK/SZS 9.21.13				€/Kč
		DN [mm]	L [mm]	L ₁ [mm]	NG=A	
K	80	250	85	210	170	20,30/529
	100	250	85	210	170	21,70/563
	113	250	85	210	170	23,00/598
	130	250	85	220	180	25,80/672
	150	250	85	245	205	29,60/771
S	180	290	105	265	225	47,30/1230
	200	290	105	284	244	50,50/1314
	225	290	105	304	264	55,00/1431
	250	290	105	334	294	59,10/1536
	300	320	120	356	316	71,00/1847
	355	320	120	404	364	81,00/2106
	400	320	120	456	416	90,20/2344
	500	320	120	604	564	113,00/2938
600	320	120	702	662	132,30/3441	

KONTROLNÝ OTVOR | KONTROLNÍ OTVOR | INSPECTION HOLE | DAS KONTROLLLOCH | ELLENŐRZŐ NYÍLÁS

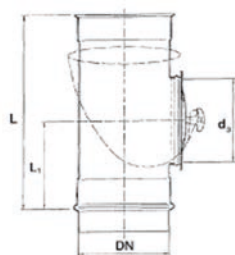

typ spoja	kód	REK/RES 6.25.33			€/Kč
		DN [mm]	L [mm]	L ₁ [mm]	
K	80	245	115	80	31,80/827
	100	265	125	100	34,70/902
	113	300	135	113	37,90/985
	130	315	140	130	41,60/1083
	150	335	150	150	46,00/1195
S	180	335	165	150	53,70/1396
	200	335	165	150	55,50/1443
	225	335	165	150	57,90/1504
	250	335	165	150	60,40/1570
	300	335	165	150	65,00/1691
	355	335	165	150	70,20/1825
	400	335	165	150	81,50/2119
	500	335	165	150	95,80/2491
600	335	165	150	113,30/2946	

INOX AGS

INOX AGS

komponenty INOX | components INOX | komponente | INOX elemek
bez povrchovej úpravy | uncoated | unbeschichtet | bevonat nélkül
EN 1856 - T200 - P1 - W - V2 - L50060 - O(100) - L50100



Komponenty dymovodov - INOX jednovrstvový pretlakový systém Kaminodur AGS teplotná trieda T200

KRYT KOMÍNA | KRYT KOMÍNA | CHIMNEY COVER | SCHORNSTEINABDECKUNG | KÉMÉNY FEDÉL

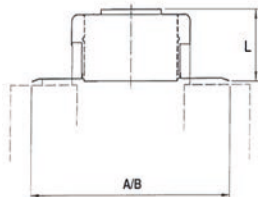

kód	ABL 6.50.76		
DN [mm]	L [mm]	A/B	€/Kč
80	180	202	45,50/1183
100		225	45,60/1185
113		225	45,60/1185
130		244	45,60/1185
150		264	51,90/1350
180		294	51,90/1350
200		316	60,50/1573
225		341	60,50/1573
250		364	60,60/1575
300		416	84,80/2206
355		467	113,40/2949
400		513	113,50/2950
500		614	176,90/4598
600		714	177,10/4604

KRYT ZAÚSTENIA | KRYT ZAÚSTĚNÍ | INLET COVER | EINLASSABDECKUNG | TAKARÓ LEMEZ

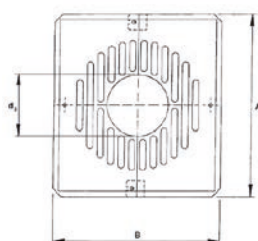
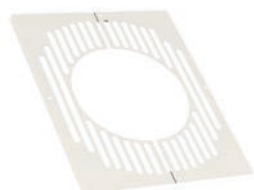

kód	ELS 6.24.13		
DN [mm]	A/B	d ₃ [mm]	€/Kč
80	420/280	86	11,70/304
100	420/280	106	11,80/306
113	420/280	119	12,00/312
130	420/280	136	12,00/312
150	420/280	156	12,00/312
180	400/350	186	13,20/343
200	400/350	206	14,10/368
225	500/400	235	16,70/435
250	500/400	258	16,70/435
300	550/500	308	20,80/541
355	550/500	365	21,00/546
400	700/700	410	31,80/826
500	800/800	510	39,20/1020
600	900/900	610	47,80/1242

INOX AGS

INOX AGS

komponenty INOX | components INOX | komponente | INOX elemek
 bez povrchovej úpravy | uncoated | unbeschichtet | bevonat nélkül
 EN 1856 - T200 - P1 - W - V2 - L50060 - O(100) - L50100



Komponenty dymovodov - INOX jednovrstvový pretlakový systém Kaminodur AGS teplotná trieda T200



ZBERAČ KONDENZÁTU | SBĚRAČ KONDENZÁTU | CONDENSATE COLLECTOR | KONDENSATSAMMLER | KONDENZÁTUMGYŰJTŐ

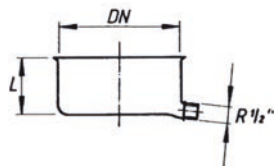

typ spoja	kód	KOK/KOS 6.31.13	
	DN [mm]	L [mm]	€/Kč
K	80	75	18,60/483
	100		19,00/494
	113		19,80/514
	130		21,10/548
	150		23,20/603
S	180		26,40/688
	200		27,50/716
	225		28,70/745
	250		29,90/777
	300		32,80/853
	355		35,40/921
	400		45,00/1171
	500		58,20/1513
	600		73,40/1909

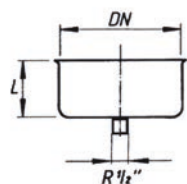

typ spoja	kód	KOK/KOS 6.31.14	
	DN [mm]	L [mm]	€/Kč
K	80	75	18,60/483
	100		19,00/494
	113		19,80/514
	130		21,10/548
	150		23,20/603
S	180		26,40/688
	200		27,50/716
	225		28,70/745
	250		29,90/777
	300		32,80/853
	355		35,40/921
	400		45,00/1171
	500		58,20/1513
	600		73,40/1909

INOX AGS

INOX AGS

komponenty INOX | components INOX | komponente | INOX elemek
bez povrchovej úpravy | uncoated | unbeschichtet | bevonat nélkül
EN 1856 - T200 - P1 - W - V2 - L50060 - O(100) - L50100



Komponenty dymovodov - INOX jednovrstvový pretlakový systém Kaminodur AGS teplotná trieda T200

PŘÍPOJKA SPOTREBIČA | PŘÍPOJKA SPOTŘEBIČE | APPLIANCE CONNECTION | GERÄTEANSCHLUSS | KÉSZÜLÉK CSATLAKOZTATÁSA

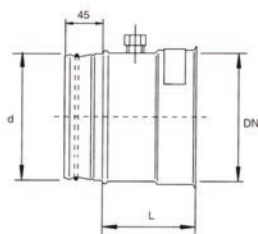

pre montáž zasunutím

L= 120 mm : d=DN
L= 150 mm : d<<DN/d>>DN

typ spoja	kód	KAK/KAS 4.11.13	
	DN [mm]	L [mm]	€/Kč
K	80	120	14,10/366
	100		16,40/426
	113		16,80/438
	130		18,30/475
	150		19,20/499
S	180		20,00/520
	200		21,10/548
	225		22,10/575
	250		23,10/602
	300		25,50/662
	355		27,10/602
	400		30,10/781
	500		35,20/915
600	40,20/1046		

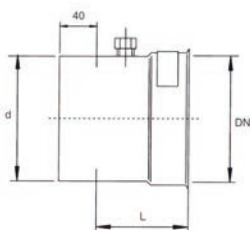

pre montáž nasunutím

L= 120 mm : d=DN
L= 150 mm : d<<DN/d>>DN

typ spoja	kód	KAK/KAS 4.11.63	
	DN [mm]	L [mm]	€/Kč
K	80	120	13,70/357
	100		14,40/374
	113		15,20/395
	130		16,00/416
	150		16,90/439
S	180		17,00/442
	200		17,20/446
	225		18,20/472
	250		19,10/495
	300		21,10/548
	355		23,10/601
	400		25,00/649
	500		29,00/755
600	33,00/857		

INOX AGS

INOX AGS

komponenty INOX | components INOX | komponente | INOX elemek
 bez povrchovej úpravy | uncoated | unbeschichtet | bevonat nélkül
 EN 1856 - T200 - P1 - W - V2 - L50060 - O(100) - L50100



Komponenty dymovodov - INOX jednovrstvový pretlakový systém Kaminodur AGS teplotná trieda T200

REDUKCIE | REDUKCE | REDUCER | REDUKTION | SZŰKÍTŐ ELEM

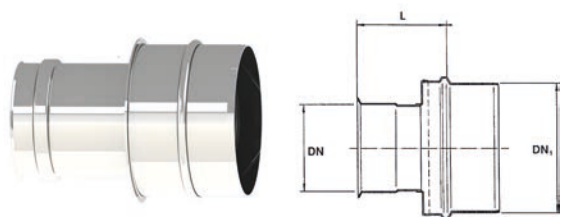

DN - podľa požiadavky.

typ spoja	kód	USK/USS 4.19.03	
	DN ₁ [mm]	L [mm]	€/Kč
K	80	150	16,20/422
	100		17,50/456
	113		19,20/498
	130		21,20/550
	150		22,40/582
S	180		26,00/677
	200		28,40/738
	225		30,70/797
	250		33,40/867
	300		37,90/985
	355		43,90/1141
	400		50,70/1319
	500		62,70/1629
600	76,20/1981		

ROZŠIROVACÍ DIEL | REDUKCE | REDUCER | REDUKTION | BŐVÍTŐK

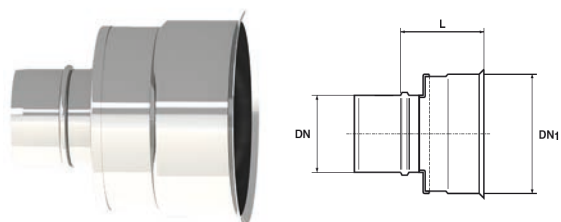

DN - podľa požiadavky.

typ spoja	kód	USK/USS 4.20.03	
	DN ₁ [mm]	L [mm]	€/Kč
K	80	150	17,50/456
	100		19,20/498
	113		19,70/511
	130		22,40/582
	150		26,00/677
S	180		28,40/738
	200		30,70/797
	225		33,40/867
	250		37,90/985
	300		43,90/1141
	355		50,70/1319
	400		62,70/1629
	500		76,20/1981
600			

INOX AGS

INOX AGS

komponenty INOX | components INOX | komponente | INOX elemek
bez povrchovej úpravy | uncoated | unbeschichtet | bevonat nélkül
EN 1856 - T200 - P1 - W - V2 - L50060 - O(100) - L50100



Komponenty dymovodov - INOX jednovrstvový pretlakový systém Kaminodur AGS teplotná trieda T200

SPOJOVACIE HRDLO S TESNENÍM | SPOJOVACÍ HRDLO S TĚSNĚNÍM | SEAL COUPLING | KUPPLUNG ABDICHTEN | TÖMÍTÉSSEL
ELLÁTOTT PEREM A CSÖVEK RÖVIDÍTÉSÉHEZ

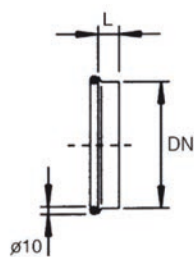

Použití s objímkou SSS 5.25.10 při úprave
délky v místě stavby

kód	VKS 5.26.13	
DN [mm]	L [mm]	€/Kč
180	25	6,10/160
200		6,60/172
225		7,40/191
250		7,80/204
300		9,00/234
355		10,30/267
400		11,40/296
500		13,90/361
600	16,30/424	

SPOJOVACIA OBJÍMKA S TESNENÍM | SPOJOVACÍ OBJÍMKA S TĚSNĚNÍM | CONNECTING SLEEVE WITH GASKET | VERBINDUNGSMUFFE
MIT DICHTUNG | BILINCS TÖMÍTÉSSEL

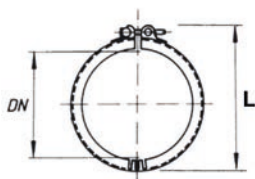

Použitie nutné pri spájaní rúr

kód	SSS 5.25.13	
DN [mm]	L [mm]	€/Kč
180	220	14,90/389
200	240	15,40/401
225	265	16,10/418
250	290	16,80/438
300	340	18,40/478
355	395	19,60/509
400	440	20,70/537
500	540	24,20/630
600	640	28,40/738

INOX AGS

INOX AGS

komponenty INOX | components INOX | komponente | INOX elemek
 bez povrchovej úpravy | uncoated | unbeschichtet | bevonat nélkül
 EN 1856 - T200 - P1 - W - V2 - L50060 - O(100) - L50100

Komponenty dymovodov - INOX jednovrstvový pretlakový systém Kaminodur AGS
 teplotná trieda T200

SPOJOVACIA OBJÍMKA | SPOJOVACÍ OBJÍMKA | CONNECTING SLEEVE | VERBINDUNGSMUFFE | ERŐSÍTETT BILINCS



kód	SSM 5.75.13	
DN [mm]		€/Kč
80		3,80/99
100		3,90/102
113		4,00/103
130		4,00/103
150		4,10/106

TESZENIE | TĚSNĚNÍ | GASKET | DICHTUNG | TÖMÍTŐ GYŰRŰ



kód	DIM 5.24.78	
DN [mm]	L [mm]	€/Kč
80	86,9	2,80/73
100	108,8	3,20/82
113	122,2	3,40/88
130	139,2	3,70/96
150	159,2	4,10/106
180	189,2	4,50/121
200	209,2	5,00/130
225	234,2	5,50/142
250	259,2	5,90/154
300	309,6	6,80/177
355	364,6	7,80/204
400	409,6	8,70/225
500	509,6	9,60/249
600	609,6	10,50/272

UPEVŇOVACÍ MOSTÍK PRE ZVISLÚ MONTÁŽ | UPEVŇOVACÍ MŮSTEK PRO SVISLOU MONTÁŽ | MOUNTING BRACKET FOR VERTICAL MOUNTING | MONTAGEHALTERUNG FÜR VERTIKALE MONTAGE | TARTÓSZERKEZET FÜGGŐLEGES SZERELÉSHEZ

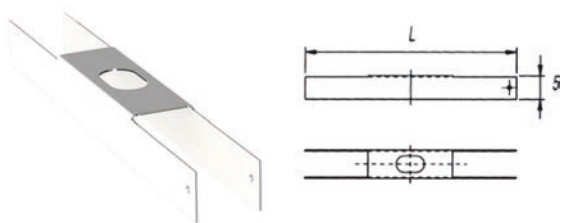

kód	HAL 9.42.22	
DN [mm]	L [mm]	€/Kč
80	120	11,90/309
100	120	11,90/309
113	120	11,90/309
130	120	11,90/309
150	120	11,90/309
180	120	11,90/309
200	120	11,90/309
225	120	11,90/309
250	120	11,90/309

INOX AGS

INOX AGS

komponenty INOX | components INOX | komponente | INOX elemek
bez povrchovej úpravy | uncoated | unbeschichtet | bevonat nélkül
EN 1856 - T200 - P1 - W - V2 - L50060 - O(100) - L50100



Komponenty dymovodov - INOX jednovrstvový pretlakový systém Kaminodur AGS teplotná trieda T200

VYPÚŠŤACIA RÚRA, SIFÓN | VYPOUŠŤECÍ TRUBKA, SIFON | DRAIN PIPE, SIPHON | ABFLUSSROHR, SIPHON | LEFOLYÓCSŐ, SZIFON

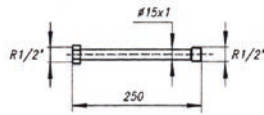

kód	ALA 6.31.24	
R	L [mm]	€/Kč
1/2"	250	10,80/281

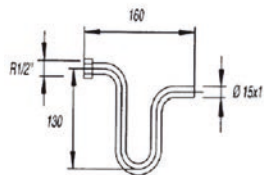

kód	ALA 6.31.33	
R	L [mm]	€/Kč
1/2"	160	10,10/263

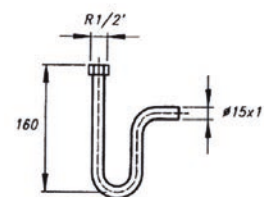

kód	ALA 6.31.63	
R	L [mm]	€/Kč
1/2"	160	10,10/263

INOX AGS

INOX ERS/EAD

komponenty INOX | components INOX | komponente | INOX elemek
 bez povrchovej úpravy | uncoated | unbeschichtet | bevonat nélkül
 EN 1856 - T400 - N1 - W - V2 - L50060 - O(100) - L50100
 EN 1856 - T400 - N1 - D - V3 - L50060 - G(300) - L50100
 EN 1856 - T200 - P1 - W - V2 - L50060 - O(100) - L50100



Komponenty dymovodov - INOX trojvrstvý systém Kaminodur ERS/EAD teplotná trieda T400/T200

DĚLKOVÝ DÍL | DÉLKOVÝ DÍL | LENGTH PART | LÄNGE TEIL | CSŐ



kód	ROU 1.10.03 A					
DN [mm]	L [mm]	€/Kč	L [mm]	€/Kč	L [mm]	€/Kč
80		21,90/569		33,70/876		51,80/1347
100		23,30/606		35,80/932		55,10/1433
113		24,00/623		36,90/959		56,70/1475
130		26,70/694		41,00/1067		63,10/1642
150		29,00/754		44,60/1160		68,70/1785
180		33,00/858		50,70/1319		78,10/2030
200		36,10/939		55,50/1444		85,50/2222
225	250	39,00/1014	500	60,00/1560	1000	92,30/2399
250		43,00/1117		66,10/1718		101,70/2643
300		46,90/1220		72,20/1876		111,00/2887
355		54,20/1409		83,40/2168		128,30/3336
400		61,20/1592		94,20/2449		144,90/3768
450		70,50/1834		108,50/2821		166,90/4340
500		77,40/2014		119,10/3098		183,30/4766
600		94,10/2446		144,70/3763		222,60/5789

ZAÚŠŤOVACÍ DÍEL 90° | ZAÚŠŤOVACÍ DÍL 90° | PLUG-IN PIECE 90° | EINSTECKSTÜCK 90° | 90° T-IDOM

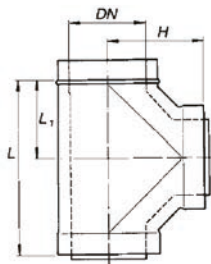

kód	ATU 3.13.90 A				€/Kč
DN [mm]	L [mm]	L ₁ [mm]	H [mm]		
80	400	200	180		79,30/2061
100	400	200	190		80,60/2097
113	400	175	200		73,00/1898
130	400	175	205		76,20/1982
150	400	175	215		87,30/2271
180	500	250	230		96,80/2517
200	500	250	240		116,50/3028
225	500	225	255		131,90/3429
250	500	225	265		155,30/4039
300	600	280	295		189,30/4922
355	600	280	320		207,60/5397
400	700	330	340		240,00/6241
450	700	330	370		271,50/7060
500	850	435	390		312,80/8133
600	850	405	440		359,20/9340

INOX
ERS/EAD

INOX ERS/EAD

komponenty INOX | components INOX | komponente | INOX elemek
bez povrchovej úpravy | uncoated | unbeschichtet | bevonat nélkül
EN 1856 - T400 - N1 - W - V2 - L50060 - O(100) - L50100
EN 1856 - T400 - N1 - D - V3 - L50060 - G(300) - L50100
EN 1856 - T200 - P1 - W - V2 - L50060 - O(100) - L50100



Komponenty dymovodov - INOX trojvrstvý systém Kaminodur ERS/EAD teplotná trieda T400/T200

ZAÚŠŤOVACÍ DIEL 45° | ZAÚŠŤOVACÍ DÍL 45° | PLUG-IN PIECE 45° | EINSTECKSTÜCK 45° | 45° T-IDOM

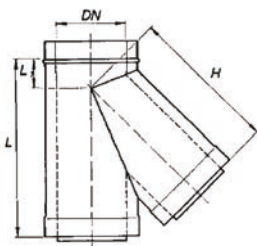

kód		ATU 3.10.45 A			
DN [mm]	L [mm]	L ₁ [mm]	H [mm]	€/Kč	
113	335	60	275	90,00/2340	
130	365	65	300	97,00/2522	
150	390	65	325	111,80/2907	
180	435	75	360	121,80/3166	
200	460	75	385	147,50/3834	
225	505	85	420	171,80/4468	
250	530	85	445	184,20/4788	
300	610	100	510	227,40/5911	
355	675	110	565	264,40/6874	
400	745	120	625	296,20/7702	
450	820	130	690	361,20/9391	
500	890	140	750	416,40/10826	
600	1030	160	870	573,30/14906	

ZAÚŠŤOVACÍ DIEL 87° S UPEVŇOVACOU PLATŇOU | ZAÚŠŤOVACÍ DÍL 87° S UPEVŇOVACÍ DESKOU | PLUG-IN PIECE 87° WITH MOUNTING
PLATE | EINSTECKSTÜCK 87° MIT MONTAGEPLATTE | 87° TALPAS KÖNYÖK RÓGZITŐ LEMEZSEL

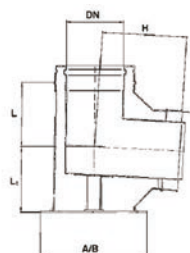

kód		ESU 2.40.87 A				
DN [mm]	L [mm]	L ₁ [mm]	H [mm]	A/B	€/Kč	
80	175	140	180	202	87,70/2280,	
100	175	140	190	225	93,90/2441	
113	200	165	195	225	97,10/2525	
130	200	165	205	244	104,20/2710	
150	200	165	215	264	112,40/2922	
180	225	190	230	294	129,60/3370	
200	225	190	245	316	140,00/3639	
225	250	215	255	341	151,40/3935	
250	250	215	265	364	160,10/4163	
300	275	260	295	416	191,00/4965	
355	300	275	320	467	207,60/5397	
400	325	300	340	513	240,00/6241	
450	350	325	365	564	271,50/7060	
500	375	355	390	614	312,80/8133	
600	425	400	440	714	359,20/9340	

INOX ERS/EAD

komponenty INOX | components INOX | komponente | INOX elemek
 bez povrchovej úpravy | uncoated | unbeschichtet | bevonat nélkül
 EN 1856 - T400 - N1 - W - V2 - L50060 - O(100) - L50100
 EN 1856 - T400 - N1 - D - V3 - L50060 - G(300) - L50100
 EN 1856 - T200 - P1 - W - V2 - L50060 - O(100) - L50100



Komponenty dymovodov - INOX trojvrstvý systém Kaminodur ERS/EAD teplotná trieda T400/T200

ZAÚŠŤOVACÍ DIEL 87° S UPEVNŔOVACOU PLATŇOU A KONTROLNÝM OTVOROM | ZAÚŠŤOVACÍ DÍL 87° S UPEVNŔOVACÍ DESKOU A KONTROLNÍM OTVOREM | PLUG-IN PIECE 87° WITH MOUNTING PLATE AND INSPECTION HOLE | EINSTECKSTÜCK 87° MIT MONTAGEPLATTE UND REVISIONSÖFFNUNG | 87° TALPAS KÖNYÖK ELLENÖRZŐ NYÍLÁSSAL

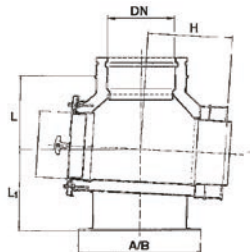

kód	ESU 2.41.87 A					
DN [mm]	L [mm]	L ₁ [mm]	H [mm]	d ₃ [mm]	A/B	€/Kč
80	175	140	180	80	202	143,20/3724
100	175	140	190	100	225	147,50/3834
113	200	165	195	113	225	151,70/3944
130	200	165	205	130	244	160,80/4181
150	200	165	215	150	264	176,70/4594
180	225	190	230	150	294	188,40/4898
200	225	190	245	150	316	203,30/5287
225	250	215	255	150	341	217,60/5658
250	250	215	265	150	364	226,40/5886
300	275	260	295	250	416	261,50/6798
355	300	275	320	250	467	310,50/8074
400	325	300	340	250	513	328,70/8546
450	350	325	365	250	564	362,50/9424
500	375	355	390	250	614	387,80/10083
600	425	400	440	250	714	444,30/11552

KONTROLNÝ OTVOR 120/180 | KONTROLNÍ OTVOR 120/180 | INSPECTION HOLE 120/180 | REVISIONSÖFFNUNG 120/180 | ELLENÖRZŐ AJTÓ 120/180

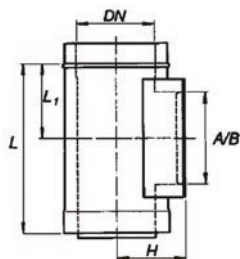

kód	REU 6.25.25 A				
DN [mm]	L [mm]	L ₁ [mm]	H [mm]	€/Kč	
113	360	160	110	99,00/2573	
130			120	105,90/2753	
150			130	110,20/2866	
180			145	114,70/2983	
200			155	121,10/3148	
225			170	126,10/3279	
250			180	137,80/3582	
300			210	150,90/3924	
355			230	202,50/5266	
400			255	211,60/5501	
450			280	228,00/5929	
500			305	245,60/6385	
600	355	283,60/7374			

INOX
ERS/EAD

INOX ERS/EAD

komponenty INOX | components INOX | komponente | INOX elemek
 bez povrchovej úpravy | uncoated | unbeschichtet | bevonat nélkül
 EN 1856 - T400 - N1 - W - V2 - L50060 - O(100) - L50100
 EN 1856 - T400 - N1 - D - V3 - L50060 - G(300) - L50100
 EN 1856 - T200 - P1 - W - V2 - L50060 - O(100) - L50100



Komponenty dymovodov - INOX trojvrstvý systém Kaminodur ERS/EAD teplotná trieda T400/T200

KONTROLNÝ OTVOR 150/300 | KONTROLNÍ OTVOR 150/300 | INSPECTION HOLE 150/300 | REVISIONSÖFFNUNG 150/300 |
 ELLENŐRZŐ AJTÓ 150/300

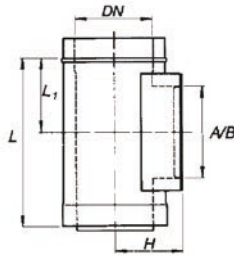

kód	REU 6.25.26 A			€/Kč
DN [mm]	L [mm]	L ₁ [mm]	H [mm]	
113	480	220	110	145,70/3787
130			120	151,00/3927
150			130	155,70/4048
180			145	162,20/4216
200			155	169,10/4395
225			170	182,30/4739
250			180	188,10/4891
300			210	202,70/5269
355			230	213,70/5556
400			255	222,80/5792
450			280	239,30/6221
500			305	256,90/6680
600	355	295,10/7672		

KONTROLNÝ OTVOR KRUHOVÝ | KONTROLNÍ OTVOR KRUHOVÝ | INSPECTION HOLE CIRCULAR | REVISIONSÖFFNUNG RUNDE |
 KERÉK ELLENŐRZŐ NYILÁS

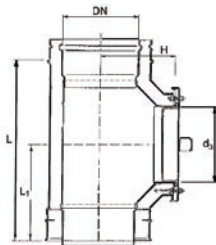

kód	REU 6.25.30 A				€/Kč
DN [mm]	L [mm]	L ₁ [mm]	H [mm]	d ₃ [mm]	
80	400	200	141	80	107,60/2797
100	400	200	152	100	118,40/3079
113	400	225	152	113	119,10/3095
130	400	225	162	130	126,00/3275
150	400	225	172	150	131,30/3413
180	400	250	187	150	140,00/3641
200	500	275	198	150	153,20/3982
225	500	275	210	150	161,40/4196
250	500	275	222	150	168,70/4385
300	500	275	253	250	178,60/4643
355	500	275	278	250	219,80/5716
400	500	275	301	250	232,10/6034
450	500	275	327	250	257,20/6688
500	500	275	352	250	275,40/7160
600	500	275	402	250	314,50/8178

INOX
ERS/EAD

INOX ERS/EAD

komponenty INOX | components INOX | komponente | INOX elemek
bez povrchovej úpravy | uncoated | unbeschichtet | bevonat nélkül
EN 1856 - T400 - N1 - W - V2 - L50060 - O(100) - L50100
EN 1856 - T400 - N1 - D - V3 - L50060 - G(300) - L50100
EN 1856 - T200 - P1 - W - V2 - L50060 - O(100) - L50100



Komponenty dymovodov - INOX trojvrstvý systém Kaminodur ERS/EAD teplotná trieda T400/T200

ZBERAČ KONDENZÁTU S UPEVŇOVACOU PLATŇOU | SBĚRAČ KONDENZÁTU S UPEVŇOVACÍ DESKOU | CONDENSATE COLLECTOR WITH MOUNTING PLATE | KONDENSATSAMMLER MIT MONTAGEPLATTE | KONDENZÁTUMGYŰJTŐ RÖGZÍTŐLEMEZZEL

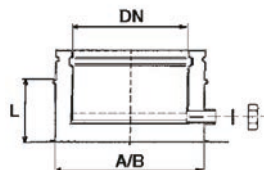

kód	KOU 6.31.13 A		
DN [mm]	L [mm]	A/B	€/Kč
80	85	202	44,10/1148
100		225	46,00/1195
113		225	46,40/1206
130		244	49,70/1293
150		264	52,90/1375
180		294	57,80/1504
200		316	61,90/1611
225		341	69,30/1802
250		364	73,70/1917
300		416	85,00/2211
355		467	94,90/2467
400		513	108,00/2809
450		564	120,80/3141
500		614	134,40/3494
600		714	163,80/4260

ZBERAČ SADZÍ S VÝVODOM | SBĚRAČ SAZÍ S VÝVODEM | SOOT COLLECTOR WITH OUTLET | RUSSAMMLER MIT AUSLAUF | KOROMGYŰJTŐ KIMENETTEL

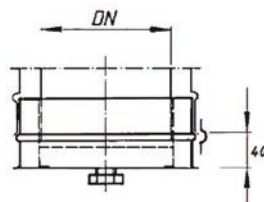

kód	VDU 6.32.03 A	
DN [mm]	L [mm]	€/Kč
113	40	24,90/648
130		26,70/694
150		28,60/744
180		31,50/818
200		33,70/877
225		36,30/944
250		38,80/1009
300		44,90/1167
355		51,30/1333
400		57,70/1501
450		65,50/1704
500		71,10/1849
600	90,60/2356	

INOX
ERS/EAD

INOX ERS/EAD

komponenty INOX | components INOX | komponente | INOX elemek
 bez povrchovej úpravy | uncoated | unbeschichtet | bevonat nélkül
 EN 1856 - T400 - N1 - W - V2 - L50060 - O(100) - L50100
 EN 1856 - T400 - N1 - D - V3 - L50060 - G(300) - L50100
 EN 1856 - T200 - P1 - W - V2 - L50060 - O(100) - L50100



Komponenty dymovodov - INOX trojvrstvý systém Kaminodur ERS/EAD teplotná trieda T400/T200

TELESKOPICKÝ POSUVNÝ DIEL | TELESKOPICKÝ POSUVNÝ DÍL | TELESCOPIC SLIDE | TELESKOPSCHLITTEN | TELESZKÓPOS CSŐ

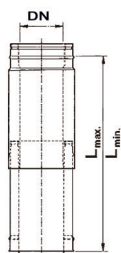

kód	TKU 1.15.03 A		
DN [mm]	L _{min} [mm]	L _{max} [mm]	€/Kč
113	320	470	78,90/2052
130			86,00/2237
150			92,50/2406
180			102,80/2672
200			111,50/2898
225			120,40/3129
250			130,90/3405
300			142,90/3715
355			158,70/4127
400			189,80/4934
450			213,60/5553
500			233,00/6057
600			275,80/7170

DĚLKOVÝ DIEL S 3X NÁTRUBKOM | DÉLKOVÝ DÍL S 3X NÁTRUBKEM | LENGTH PART WITH 3X SLEEVE | LÄNGE TEIL MIT 3X HÜLSE |
 CSŐ 3X 1/2 MÉRŐNYÍLÁSOKKAL

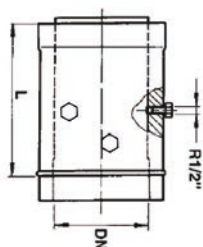

kód	ROU 1.18.33 A	
DN [mm]	L [mm]	€/Kč
80	250	53,20/1383
100		55,80/1450
113		56,60/1472
130		60,10/1562
150		63,60/1654
180		67,80/1764
200		71,80/1868
225		78,00/2027
250		82,50/2145
300		88,80/2308
355		100,90/2623
400		115,60/3005
450		128,40/3339
500		138,70/3605
600	167,70/4360	

INOX
ERS/EAD

INOX ERS/EAD

komponenty INOX | components INOX | komponente | INOX elemek
 bez povrchovej úpravy | uncoated | unbeschichtet | bevonat nélkül
 EN 1856 - T400 - N1 - W - V2 - L50060 - O(100) - L50100
 EN 1856 - T400 - N1 - D - V3 - L50060 - G(300) - L50100
 EN 1856 - T200 - P1 - W - V2 - L50060 - O(100) - L50100



Komponenty dymovodov - INOX trojvrstvý systém Kaminodur ERS/EAD teplotná trieda T400/T200

MEDZIKUS S UPEVŇOVACOU PLATŇOU | MEZIKUS S UPEVŇOVACÍ DESKOU | SPACER WITH MOUNTING PLATE | ABSTANDSHALTER MIT MONTAGEPLATTE | TARTÓ CSŐ RÖGZÍTŐ LEMEZZEL

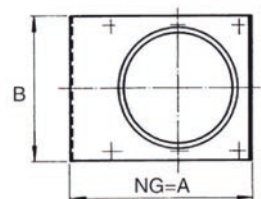
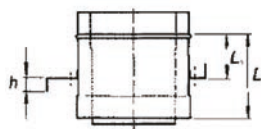

kód	SZU 9.21.03 A			
DN [mm]	L [mm]	L ₁ [mm]	A/B	€/Kč
80	250	150	202	37,30/970
100			225	38,90/1011
113			225	37,90/984
130			244	41,90/1089
150			264	46,00/1195
180			294	51,60/1342
200			316	54,10/1406
225			341	62,60/1629
250			364	71,50/1858
300			416	80,80/2100
355			467	95,40/2479
400			513	126,20/3282
450			564	115,00/2989
500			614	128,40/3339
600			714	150,00/3900

MEDZIKUS S DILATAČNOU RÚROU A UPEVŇOVACOU PLATŇOU | MEZIKUS S DILATAČNÍ TRUBKOU A UPEVŇOVACÍ DESKOU | SPACER WITH DILATATION PIPE AND MOUNTING PLATE | ABSTANDSHALTER MIT DILATIONSROHR UND MONTAGEPLATTE | TDILATÁCIÓS CSŐ RÖGZÍTŐ LEMEZZEL

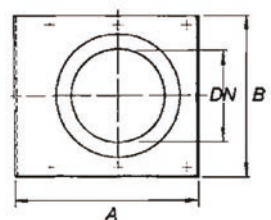
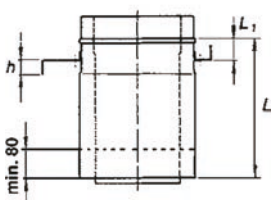

kód	SZU 9.21.13 A			
DN [mm]	L [mm]	L ₁ [mm]	A/B	€/Kč
80	200	150	202	51,90/1349
100			225	57,00/1483
113			225	57,90/1505
130			244	63,10/1640
150			264	68,20/1773
180			294	76,00/1975
200			316	82,40/2142
225			341	92,10/2394
250			364	100,60/2616
300			416	111,20/2892
355			467	122,30/3180
400			513	145,90/3794
450			564	164,90/4286
500			614	182,40/4741
600			714	216,80/5637

INOX
ERS/EAD

INOX ERS/EAD

komponenty INOX | components INOX | komponente | INOX elemek
 bez povrchovej úpravy | uncoated | unbeschichtet | bevonat nélkül
 EN 1856 - T400 - N1 - W - V2 - L50060 - O(100) - L50100
 EN 1856 - T400 - N1 - D - V3 - L50060 - G(300) - L50100
 EN 1856 - T200 - P1 - W - V2 - L50060 - O(100) - L50100



Komponenty dymovodov - INOX trojvrstvý systém Kaminodur ERS/EAD teplotná trieda T400/T200

KOLENO 90° S KONTROLNÝM OTVOROM | KOLENO 90° S KONTROLNÍM OTVOREM | ELBOW 90° WITH INSPECTION HOLE | BOGEN 90° MIT REVISIONSÖFFNUNG | 90° - OS KÖNYÖK ELLENŐRZŐ NYÍLÁSSAL

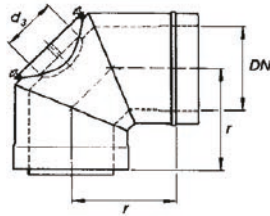

kód	BPU 2.30.90 A		
DN [mm]	r [mm]	d ₃ [mm]	€/Kč
113	165	80	62,10/1614
130	175	80	68,70/1786
150	185	100	75,90/1974
180	200	100	85,20/2215
200	210	100	92,80/2413
225	225	100	101,40/2636
250	235	150	108,70/2826
300	265	150	138,70/3607
355	355	150	157,40/4093
400	400	150	181,00/4706
450	450	150	211,10/5489
500	500	150	237,50/6175
600	600	150	294,60/7661

KOLENÁ | KOLENÁ | ELBOW | BOGEN | KÖNYÖKÖK

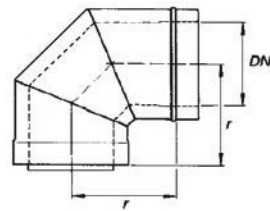

kód	BSU 2.11.90 A		
α	90°		
DN [mm]	r [mm]	d ₃ [mm]	€/Kč
113	165	80	61,40/1595
130	175	80	65,80/1711
150	185	100	70,90/1844
180	200	100	77,60/2018
200	210	100	85,60/2225
225	225	100	95,60/2484
250	235	150	107,80/2803
300	265	150	151,50/3938
355	355	150	165,30/4298
400	400	150	184,50/4798
450	450	150	193,90/5041
500	500	150	220,70/5737
600	600	150	270,00/7020

INOX
ERS/EAD

INOX ERS/EAD

komponenty INOX | components INOX | komponente | INOX elemek
bez povrchovej úpravy | uncoated | unbeschichtet | bevonat nélkül
EN 1856 - T400 - N1 - W - V2 - L50060 - O(100) - L50100
EN 1856 - T400 - N1 - D - V3 - L50060 - G(300) - L50100
EN 1856 - T200 - P1 - W - V2 - L50060 - O(100) - L50100



Komponenty dymovodov - INOX trojvrstvý systém Kaminodur ERS/EAD teplotná trieda T400/T200

KOLENÁ | KOLENÁ | ELBOW | BOGEN | KÖNYÖKÖK

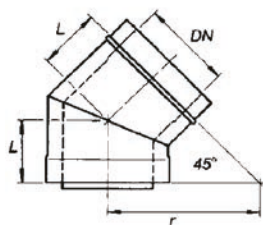

kód	BSU 2.11.45 A		
α	45°		
DN [mm]	L [mm]	r [mm]	€/Kč
113	100	240	34,00/884
130	105	255	35,80/931
150	105	255	38,20/993
180	115	280	43,00/1117
200	115	280	48,70/1266
225	125	300	55,40/1439
250	130	315	62,00/1612
300	155	375	79,70/2071
355	165	400	105,30/2738
400	175	425	127,70/3321
450	185	445	169,00/4394
500	195	470	187,50/4876
600	215	520	227,00/5902

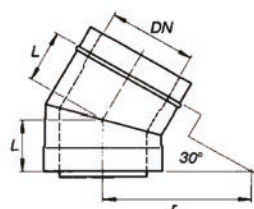

kód	BSU 2.11.30 A		
α	30°		
DN [mm]	L [mm]	r [mm]	€/Kč
113	85	320	33,00/857
130	90	335	34,20/890
150	90	335	37,90/985
180	95	355	43,20/1122
200	100	375	46,90/1220
225	105	390	50,50/1314
250	105	390	56,70/1475
300	110	410	72,10/1875
355	120	450	92,50/2405
400	125	465	117,70/3060
450	135	505	148,70/3866
500	140	525	174,50/4537
600	155	580	193,10/5019

INOX
ERS/EAD

INOX ERS/EAD

komponenty INOX | components INOX | komponente | INOX elemek
 bez povrchovej úpravy | uncoated | unbeschichtet | bevonat nélkül
 EN 1856 - T400 - N1 - W - V2 - L50060 - O(100) - L50100
 EN 1856 - T400 - N1 - D - V3 - L50060 - G(300) - L50100
 EN 1856 - T200 - P1 - W - V2 - L50060 - O(100) - L50100



Komponenty dymovodov - INOX trojvrstvý systém Kaminodur ERS/EAD teplotná trieda T400/T200

KOLENÁ | KOLENÁ | ELBOW | BOGEN | KÖNYÖKÖK

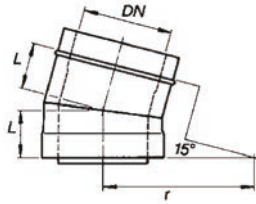

kód	BSU 2.11.15 A			
α	15°			
DN [mm]	L [mm]	r [mm]	€/Kč	
113	75	570	32,00/832	
130	75	570	32,60/847	
150	80	610	36,40/947	
180	80	610	41,70/1084	
200	80	610	45,70/1189	
225	85	645	47,30/1229	
250	85	645	54,80/1424	
300	90	685	67,20/1747	
355	90	685	83,30/2166	
400	95	720	105,90/2752	
450	100	760	135,90/3534	
500	100	760	147,90/3845	
600	110	835	176,10/4577	

UHLOVÝ DIEL 87° S KONTROLNÝM OTVOROM | ÚHLOVÝ DÍL 87° S KONTROLNÍM OTVOREM | ANGULAR PIECE 87° WITH INSPECTION
 HOLE | ECKIGES STÜCK 87° MIT REVISIONSÖFFNUNG | 87°-OS IDOM ELLENŐRZŐ NYÍLÁSSAL

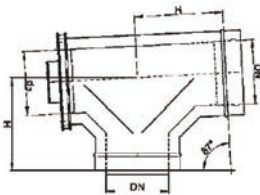

kód	WPU 2.22.87 A				
DN [mm]	L [mm]	H [mm]	d ₃ [mm]	€/Kč	
80	300	180	80	96,20/2502	
100	300	190	100	104,20/2709	
113	275	195	113	108,30/2817	
130	275	205	130	110,70/2879	
150	275	215	150	116,10/3018	
180	250	230	150	127,50/3316	
200	250	245	150	141,30/3673	
225	475	255	150	161,30/4195	
250	475	265	150	171,80/4466	
300	430	295	200	208,50/5420	
355	430	320	200	219,80/5716	
400	380	340	200	232,10/6034	
450	380	365	200	257,20/6688	
500	585	390	200	275,40/7160	
600	585	440	200	314,50/8178	

INOX
ERS/EAD

INOX ERS/EAD

komponenty INOX | components INOX | komponente | INOX elemek
 bez povrchovej úpravy | uncoated | unbeschichtet | bevonat nélkül
 EN 1856 - T400 - N1 - W - V2 - L50060 - O(100) - L50100
 EN 1856 - T400 - N1 - D - V3 - L50060 - G(300) - L50100
 EN 1856 - T200 - P1 - W - V2 - L50060 - O(100) - L50100



Komponenty dymovodov - INOX trojvrstvový systém Kaminodur ERS/EAD teplotná trieda T400/T200

UHLOVÝ DIEL 87° S KONTROLNÝM OTVOROM | ÚHLOVÝ DÍL 87° S KONTROLNÍM OTVOROM | ANGULAR PIECE 87° WITH INSPECTION
 HOLE | ECKIGES STÜCK 87° MIT REVISIONSÖFFNUNG | 87° -OS IDOM ELLENŐRZŐ NYÍLÁSSAL

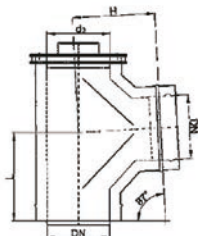

kód	WPU 2.21.87 A			
DN [mm]	L [mm]	H [mm]	d ₃ [mm]	€/Kč
80	300	180	80	96,20/2502
100	300	190	100	104,20/2709
113	275	195	113	108,30/2817
130	275	205	130	110,70/2879
150	275	215	150	116,10/3018
180	250	230	150	127,50/3316
200	250	245	150	141,30/3673
225	475	255	150	161,30/4195
250	475	265	150	171,80/4466
300	430	295	200	208,50/5420
355	430	320	200	219,80/5716
400	380	340	200	232,10/6034
450	380	365	200	257,20/6688
500	585	390	200	275,40/7160
600	585	440	200	314,50/8178

PRECHODOVÝ DIEL AGS/EAD | PŘECHODOVÝ DÍL AGS / EAD | TRANSITION PIECE AGS / EAD |
 ÜBERGANGSSTÜCK AGS / EAD | ÁTMENETI DARAB AGS / EAD

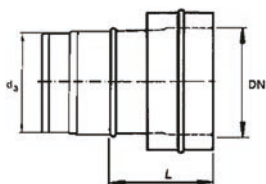

kód	USU 5.16.13			
DN [mm]	r [mm]	d ₃ [mm]	€/Kč	
80	100	77	23,10/601	
100		99	25,10/653	
113		112	26,30/683	
130		129	29,00/753	
150		149	31,30/813	
180		179	34,90/907	
200		199	37,50/975	
225		224	41,30/1073	
250		249	43,80/1139	
300		299	50,50/1313	
355		354	55,80/1450	
400		399	62,40/1622	
450		449	70,30/1828	
500		499	78,00/2029	
600		599	92,60/2408	

INOX
ERS/EAD

INOX ERS/EAD

komponenty INOX | components INOX | komponente | INOX elemek
bez povrchovej úpravy | uncoated | unbeschichtet | bevonat nélkül
EN 1856 - T400 - N1 - W - V2 - L50060 - O(100) - L50100
EN 1856 - T400 - N1 - D - V3 - L50060 - G(300) - L50100
EN 1856 - T200 - P1 - W - V2 - L50060 - O(100) - L50100



Komponenty dymovodov - INOX trojvrstvý systém Kaminodur ERS/EAD teplotná trieda T400/T200

PRECHODOVÝ DIEL SRS/ERS | PŘECHODOVÝ DÍL SRS/ERS | TRANSITION PIECE SRS/ERS |
ÜBERGANGSSTÜCK SRS/ERS | ÁTMENETI DARAB SRS/ERS

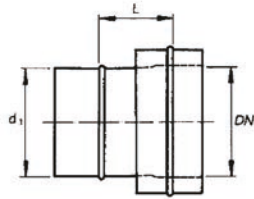

kód	USU 5.14.13 A	
DN [mm]	L [mm]	€/Kč
113	100	21,80/567
130		22,70/590
150		24,00/625
180		24,90/649
200		26,60/692
225		30,40/791
250		32,60/847
300		37,70/980
355		43,60/1133
400		51,00/1327
450		68,50/1781
500		75,60/1964
600		96,60/2512

PRECHODOVÝ DIEL EAD/AGS | PŘECHODOVÝ DÍL EAD/AGS | TRANSITION PIECE EAD/AGS |
ÜBERGANGSSTÜCK EAD/AGS | ÁTMENETI DARAB EAD/AGS

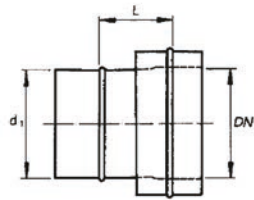

kód	USU 5.16.23	
DN [mm]	L [mm]	€/Kč
80	160	21,60/562
100		23,80/619
113		24,40/634
130		26,70/695
150		28,80/750
180		32,00/831
200		34,00/884
225		37,60/977
250		40,10/1044
300		46,20/1200
355		50,80/1320
400		58,00/1507
450		66,30/1726
500		73,30/1905
600	87,10/2265	

INOX
ERS/EAD

INOX ERS/EAD

komponenty INOX | components INOX | komponente | INOX elemek
bez povrchovej úpravy | uncoated | unbeschichtet | bevonat nélkül
EN 1856 - T400 - N1 - W - V2 - L50060 - O(100) - L50100
EN 1856 - T400 - N1 - D - V3 - L50060 - G(300) - L50100
EN 1856 - T200 - P1 - W - V2 - L50060 - O(100) - L50100



Komponenty dymovodov - INOX trojvrstvý systém Kaminodur ERS/EAD teplotná trieda T400/T200

PRECHODOVÝ DIEL ERS/SRS | PŘECHODOVÝ DÍL ERS/SRS | TRANSITION PIECE ERS/SRS |
ÜBERGANGSSTÜCK ERS/SRS | ÁTMENETI DARAB ERS/SRS

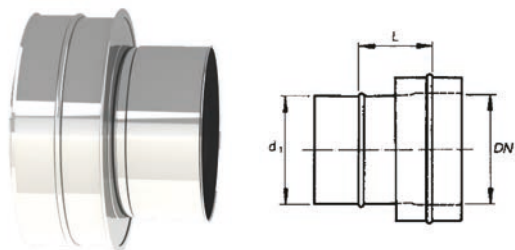

kód	USU 5.14.23	
DN [mm]	L [mm]	€/Kč
113	160	23,80/620
130		26,20/681
150		28,20/734
180		31,40/816
200		33,40/868
225		36,90/961
250		39,50/1028
300		45,50/1184
355		50,10/1302
400		57,20/1488
450		65,50/1703
500		72,40/1883
600		86,20/2242

REDUKCIE | REDUKCE | REDUCER | REDUKTION | SZŰKÍTŐ ELEM

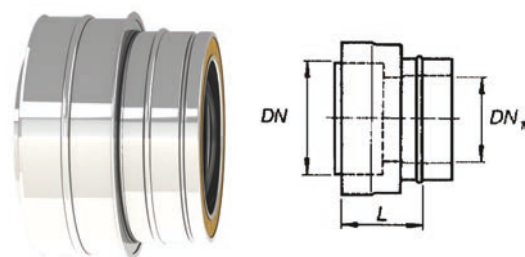

DN1 - podľa požiadavky.

kód	USU 4.19.03 A	
DN [mm]	L [mm]	€/Kč
100	110	47,10/1226
113		49,00/1275
130		51,80/1346
150		55,30/1438
180		60,00/1559
200		64,80/1684
225		69,60/1809
250		74,30/1932
300		82,20/2136
355		92,90/2415
400		101,10/2629
450		115,40/3000
500		130,60/3395
600		153,10/3981

INOX
ERS/EAD

INOX ERS/EAD

komponenty INOX | components INOX | komponente | INOX elemek
bez povrchovej úpravy | uncoated | unbeschichtet | bevonat nélkül
EN 1856 - T400 - N1 - W - V2 - L50060 - O(100) - L50100
EN 1856 - T400 - N1 - D - V3 - L50060 - G(300) - L50100
EN 1856 - T200 - P1 - W - V2 - L50060 - O(100) - L50100



Komponenty dymovodov - INOX trojvrstvý systém Kaminodur ERS/EAD teplotná trieda T400/T200

ROZŠIROVACÍ DÍL | REDUKCE | REDUCER | REDUKTION | BŐVÍTŐK

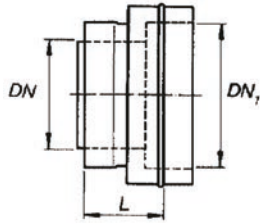

DN1 - podľa požiadavky.

kód	USU 4.20.03 A	
DN [mm]	L [mm]	€/Kč
80	110	47,60/1236
100		49,10/1276
113		52,20/1357
130		56,00/1457
150		61,00/1585
180		65,30/1697
200		69,90/1818
225		74,40/1934
250		83,50/2172
300		91,70/2383
355		103,70/2695
400		115,00/2990
450		130,10/3382
500		150,60/3916

PŘÍPOJKA SPOTREBIČA | PŘÍPOJKA SPOTŘEBIČE | APPLIANCE CONNECTION | GERÄTEANSCHLUSS | KÉSZÜLÉK CSATLAKOZTATÁSA

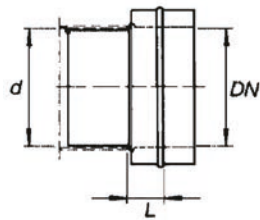

pre montáž zasunutím

kód	KAU 4.11.13 A		
DN [mm]	L [mm]	d [mm]	€/Kč
80	40	78,5	22,00/572
100		98,5	24,00/624
113		115,5	24,70/641
130		128,5	27,10/705
150		148,5	29,20/760
180		178,5	32,60/847
200		198,5	32,60/847
225		223,5	38,70/1007
250		248,5	41,00/1066
300		298,5	47,50/1234
355		353,5	52,10/1355
400		398,5	58,90/1532
450		448,5	66,70/1734
500		498,5	73,90/1922
600		598,5	89,10/2316

INOX
ERS/EAD

INOX ERS/EAD

komponenty INOX | components INOX | komponente | INOX elemek
bez povrchovej úpravy | uncoated | unbeschichtet | bevonat nélkül
EN 1856 - T400 - N1 - W - V2 - L50060 - O(100) - L50100
EN 1856 - T400 - N1 - D - V3 - L50060 - G(300) - L50100
EN 1856 - T200 - P1 - W - V2 - L50060 - O(100) - L50100



Komponenty dymovodov - INOX trojvrstvý systém Kaminodur ERS/EAD teplotná trieda T400/T200

PRÍPOJKA SPOTREBIČA | PŘÍPOJKA SPOTŘEBIČE | APPLIANCE CONNECTION | GERÄTEANSCHLUSS | KÉSZÜLÉK CSATLAKOZTATÁSA

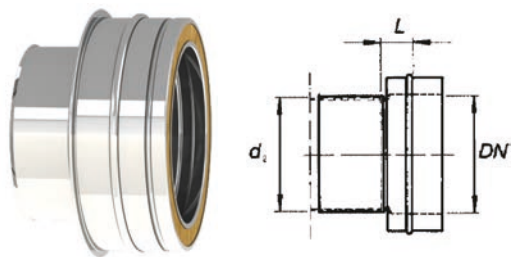

pre montáž nasunutím

kód	KAU 4.12.13 A		
DN [mm]	L[mm]	d[mm]	€/Kč
80	40	81	22,00/572
100		103	24,00/624
113		116	24,70/641
130		133	27,10/705
150		153	29,20/760
180		183	32,60/847
200		203	32,60/847
225		228	38,70/1007
250		253	41,00/1066
300		303	47,50/1234
355		358	52,10/1355
400		403	58,90/1532
450		453	66,70/1734
500		503	73,90/1922
600		603	89,10/2316

UKONČOVACÍ DIEL S UZEMŇOVACOU OBJÍMKOU | UKONČOVACÍ DÍL S UZEMŇOVACÍ OBJÍMKOU | END PIECE WITH EARTHING
SLEEVE | ENDSTÜCK MIT ERDUNGSMANSCHETTE | VÉGDARAB FÖLDELŐ BILINCSEL

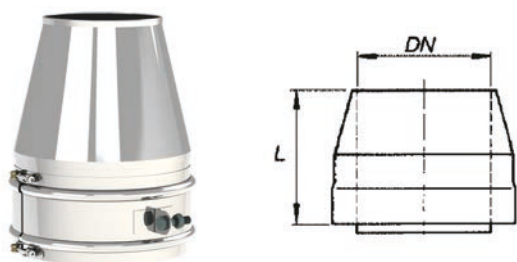

kód	ABU 6.40.03	
DN [mm]	L [mm]	€/Kč
80	150	33,00/859
100		34,30/891
113		34,80/904
130		36,30/944
150		38,20/993
180		41,10/1068
200		44,20/1149
225		46,90/1220
250		48,70/1266
300		54,60/1419
355		59,50/1548
400		66,60/1731
450		77,30/2009
500		85,00/2210
600		93,80/2439

INOX
ERS/EAD

INOX ERS/EAD

komponenty INOX | components INOX | komponente | INOX elemek
 bez povrchovej úpravy | uncoated | unbeschichtet | bevonat nélkül
 EN 1856 - T400 - N1 - W - V2 - L50060 - O(100) - L50100
 EN 1856 - T400 - N1 - D - V3 - L50060 - G(300) - L50100
 EN 1856 - T200 - P1 - W - V2 - L50060 - O(100) - L50100



Komponenty dymovodov - INOX trojvrstvý systém Kaminodur ERS/EAD teplotná trieda T400/T200

IZOLOVANÝ NÁSTAVEC S UPEVŇOVACOU PLATŇOU A DILATAČNOU RÚROU | IZOLOVANÝ NÁSTAVEC S UPEVŇOVACÍ DESKOU A DILATAČNÍ
 TROUBOU | INSULATED ATTACHMENT WITH MOUNTING PLATE AND EXPANSION TUBE | ISOLIERTER AUFSATZ MIT MONTAGEPLATTE UND
 EXPANSIONSROHR | SZIGETELT RÖGZÍTŐLEMEZ ÉS DILATÁCIÓS CSŐ

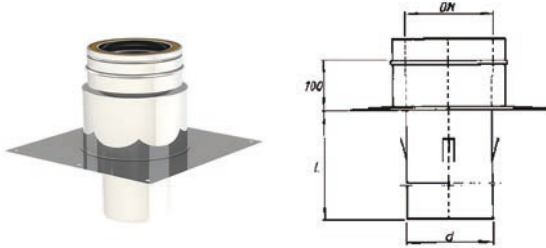

kód	AKU 6.50.23 A			
DN [mm]	L [mm]	L ₁ [mm]	A	€/Kč
113			416	64,10/1666
130			416	65,70/1707
150			416	68,70/1786
180			513	83,10/2160
200			513	86,70/2255
225			513	99,00/2573
250			513	111,90/2909
300			614	126,60/3292
355			614	137,70/3579
400			714	152,40/3962
450			714	172,00/4473
500			864	253,40/6588
600			864	288,70/7505

PRECHODKA PRE PLOCHÚ STRECHU S UPEVŇOVACOU OBJÍMKOU | PŘECHODKA PRO PLOCHOU STŘECHU S UPEVŇOVACÍ
 OBJÍMKOU | FLAT ROOF ADAPTER WITH MOUNTING BRACKET | FLACHDACHADAPTER MIT BEFESTIGUNGSWINKEL | LAPOS TETŐ
 BORITÁS TARTÓ BILINCSSEL

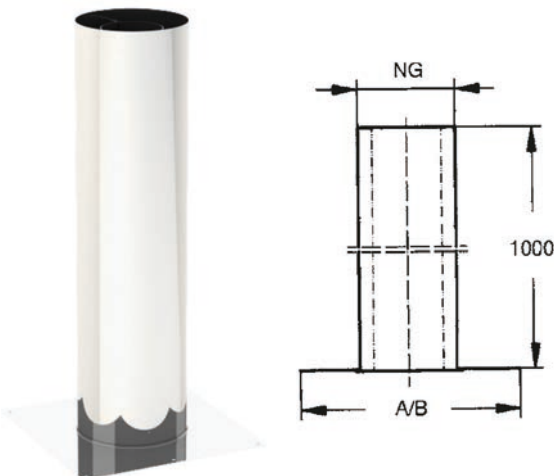

kód	FGS 6.30.70			
DN [mm]	NG [mm]	A/B	€/Kč	
80	200	513/513	93,10/2419	
100	225	513/513	98,10/2551	
113	225	513/513	98,10/2551	
130	250	513/513	103,20/2683	
150	280	513/513	109,10/2838	
180	300	513/513	113,30/2945	
200	315	714/714	143,90/3742	
225	355	714/714	151,80/3948	
250	400	714/714	161,10/4189	
300	450	714/714	171,60/4463	
355	500	714/714	182,00/4732	
400	560	864/864	220,50/5734	
450	600	864/864	232,80/6052	
500	630	864/864	239,30/6221	
600	710	900/900	264,20/6870	

INOX
ERS/EAD

INOX ERS/EAD

komponenty INOX | components INOX | komponente | INOX elemek
 bez povrchovej úpravy | uncoated | unbeschichtet | bevonat nélkül
 EN 1856 - T400 - N1 - W - V2 - L50060 - O(100) - L50100
 EN 1856 - T400 - N1 - D - V3 - L50060 - G(300) - L50100
 EN 1856 - T200 - P1 - W - V2 - L50060 - O(100) - L50100



Komponenty dymovodov - INOX trojvrstvý systém Kaminodur ERS/EAD teplotná trieda T400/T200

PRECHODKA PRE PLOCHÚ STRECHU | PŘECHODKA PRO PLOCHOU | FLAT ROOF ADAPTER | FLACHDACHADAPTER | LAPOS TETŐ
 BORITÁS

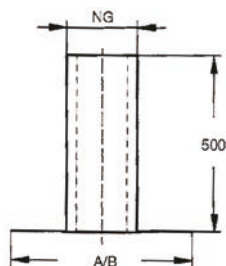

kód	FGS 6.30.13		
DN [mm]	NG[mm]	A/B	€/Kč
80	180	350/350	27,10/563
100	200	530/530	28,00/728
113	200	530/530	28,00/728
130	225	530/530	41,10/1069
150	250	530/530	43,10/1121
180	280	530/530	44,80/1165
200	300	530/530	46,90/1220
225	315	710/710	60,30/1568
250	355	710/710	63,30/1647
300	400	710/710	67,10/1745
355	450	710/710	71,50/1859
400	500	710/710	75,70/1967
450	560	710/710	80,30/2088
500	600	850/850	95,50/2482
600	710	850/850	114,40/2976

PRECHODKA PRE ŠIKMÚ STRECHU 5°-27° | PŘECHODKA PRO ŠIKMOU STŘECHU 5°-27° | SLIP FOR SLOPING ROOF 5°-27° | SLIP FÜR
 SCHRÄGDACH 5°-27° | FERDE TETŐ BORITÁS 5°-27°

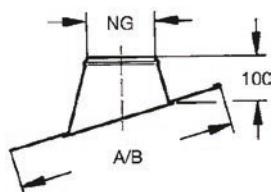

kód	FGS 6.30.15		
DN [mm]	NG[mm]	A/B	€/Kč
80	180	665/490	35,10/913
100	180	665/490	35,10/913
113	180	665/490	35,10/913
130	200	680/515	37,30/971
150	225	715/540	40,40/1049
180	250	745/570	43,60/1135
200	280	775/600	47,30/1229
225	300	800/620	50,10/1302
250	355	860/680	57,40/1494
300	400	910/730	64,70/1683
355	450	970/785	73,00/1898
400	500	1025/835	81,00/2105
450	560	1090/900	91,20/2370
500	600	1135/945	105,00/2729
600	660	1205/1010	124,60/3240

INOX
ERS/EAD

INOX ERS/EAD

komponenty INOX | components INOX | komponente | INOX elemek
 bez povrchovej úpravy | uncoated | unbeschichtet | bevonat nélkül
 EN 1856 - T400 - N1 - W - V2 - L50060 - O(100) - L50100
 EN 1856 - T400 - N1 - D - V3 - L50060 - G(300) - L50100
 EN 1856 - T200 - P1 - W - V2 - L50060 - O(100) - L50100



Komponenty dymovodov - INOX trojvrstvý systém Kaminodur ERS/EAD teplotná trieda T400/T200

PRECHODKA PRE ŠIKMÚ STRECHU 28°-50° | PŘECHODKA PRO ŠIKMOU STŘECHU 28°-50° | SLIP FOR SLOPING ROOF 28°-50° | SLIP FÜR
 SCHRÄGDACH 28°-50° | FERDE TETŐ BORITÁS 28°-50°

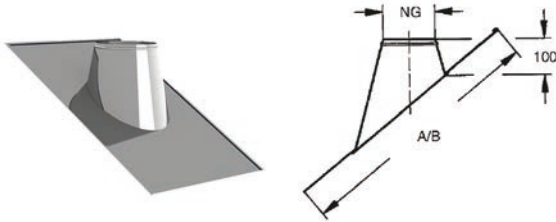

kód	FGS 6.30.16			
DN [mm]	NG[mm]	A/B	€/Kč	
80	180	785/525	47,50/1235	
100	180	785/525	47,50/1235	
113	180	785/525	47,50/1235	
130	180	785/525	52,30/1359	
150	225	785/525	57,70/1500	
180	250	860/580	63,50/1652	
200	280	860/580	71,80/1866	
225	300	900/610	79,20/2060	
250	355	950/645	97,80/2544	
300	400	980/675	114,00/2963	
355	400	1070/745	130,40/3389	
400	500	1230/855	147,10/3825	
450	560	1230/855	169,10/4395	
500	600	1310/915	185,90/4834	
600	660	1410/985	216,90/5641	

OCHRANNÝ VENIEC | OCHRANNÝ VĚNEC | PROTECTIVE WREATH | SCHUTZKRANZ | VÉDŐ GALLÉR



kód	WTK 6.52.03 A				
DN [mm]	NG[mm]	L[mm]	D [mm]	€/Kč	
80	140	100	340	10,40/270	
100	160		360	10,90/284	
113	180		380	10,90/284	
130	180		380	11,30/293	
150	200		400	12,30/321	
180	230		430	13,10/340	
200	255		455	13,60/353	
225	280		480	14,40/373	
250	300		500	14,90/387	
300	355		555	16,50/429	
355	405		605	18,70/487	
400	450		650	20,20/526	
450	500		700	21,90/570	
500	550		750	23,70/617	
600	650	850	27,70/720		

INOX
ERS/EAD

INOX ERS/EAD

komponenty INOX | components INOX | komponente | INOX elemek
 bez povrchovej úpravy | uncoated | unbeschichtet | bevonat nélkül
 EN 1856 - T400 - N1 - W - V2 - L50060 - O(100) - L50100
 EN 1856 - T400 - N1 - D - V3 - L50060 - G(300) - L50100
 EN 1856 - T200 - P1 - W - V2 - L50060 - O(100) - L50100



Komponenty dymovodov - INOX trojvrstvý systém Kaminodur ERS/EAD teplotná trieda T400/T200

STENOVÝ DRŽIAK | STĚNOVÝ DRŽÁK | WALL BRACKET | WANDHALTERUNG | FALI BILINCS



DN [mm]	80	100	113	130	150	180	200	225	250	300	355	400	450	500	600
NG[mm]	140	160	160	180	200	230	250	280	300	355	405	450	500	560	660
L[mm]	300	300	300	300	360	360	360	460	460	460	580	580	580	700	700
kód	HAL 9.12.13 W = 50÷66 mm														
€/Kč	22,90/596	22,90/596	22,90/596	22,90/596	24,90/647	25,00/651	25,10/652	30,30/787	30,40/790	31,10/809	34,40/895	34,70/902	35,00/909	37,60/978	37,80/982
kód	HAL 9.12.23 W = 100÷130 mm														
€/Kč	25,20/655	25,20/655	25,20/655	25,30/657	27,40/713	27,60/717	27,60/717	33,40/868	33,50/871	33,60/873	38,00/989	38,30/995	38,50/1001	41,70/1083	41,80/1087
kód	HAL 9.12.33 W = 130÷160 mm														
€/Kč	26,20/681	26,20/681	26,20/681	26,30/683	28,40/739	28,60/743	28,60/743	34,90/907	35,00/909	35,10/911	40,10/1042	40,30/1047	40,60/1055	43,50/1132	43,70/1136
kód	HAL 9.12.43 W = 160÷240 mm														
€/Kč	32,60/849	32,70/850	32,70/850	32,70/850	35,30/919	35,50/922	35,50/922	44,60/1159	44,70/1162	44,80/1164	48,50/1262	48,80/1268	49,00/1275	51,80/1346	51,90/1350
kód	HAL 9.12.53 W = 240÷320 mm														
€/Kč	35,10/912	35,10/912	35,10/912	35,20/914	38,30/995	38,40/999	38,40/999	44,80/1165	44,90/1168	45,00/1171	50,20/1306	50,50/1313	50,70/1319	52,30/1359	54,40/1414
kód	HAL 9.12.63 W = 320÷500 mm														
€/Kč	*	*	*	*	*	*	*	*	*	*	*	*	*	*	*

* cena na vyžiadanie

SPOJOVACIA OBJÍMKA SPEVNENÁ | SPOJOVACÍ OBJÍMKA ZPEVNĚNÁ | CONNECTING SLEEVE REINFORCED | VERBINDUNGSMUFFE
 VERSTÄRKT | ERŐSÍTETT BILINCS

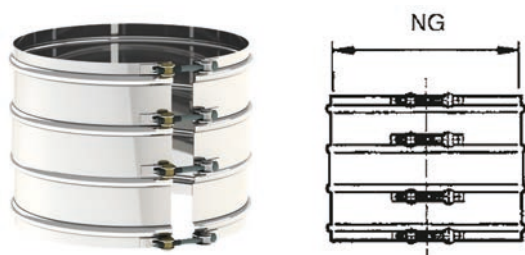

kód	SSU 5.75.23	
DN [mm]	NG[mm]	€/Kč
80	140	14,70/381
100	160	15,10/392
113	160	15,10/392
130	180	15,40/399
150	200	15,70/409
180	230	16,30/423
200	250	16,60/433
225	280	17,10/445
250	300	17,50/456
300	355	18,40/479
355	405	19,40/503
400	450	20,20/525
450	500	21,10/549
500	560	21,70/564
600	660	23,80/618

INOX
ERS/EAD

INOX ERS/EAD

komponenty INOX | components INOX | komponente | INOX elemek
 bez povrchovej úpravy | uncoated | unbeschichtet | bevonat nélkül
 EN 1856 - T400 - N1 - W - V2 - L50060 - O(100) - L50100
 EN 1856 - T400 - N1 - D - V3 - L50060 - G(300) - L50100
 EN 1856 - T200 - P1 - W - V2 - L50060 - O(100) - L50100



Komponenty dymovodov - INOX trojvrstvý systém Kaminodur ERS/EAD teplotná trieda T400/T200

STENOVÁ KONZOLA | STĚNOVÁ KONZOLA | WALL CONSOLE | WANDKONSOLE | FALI KONZOL

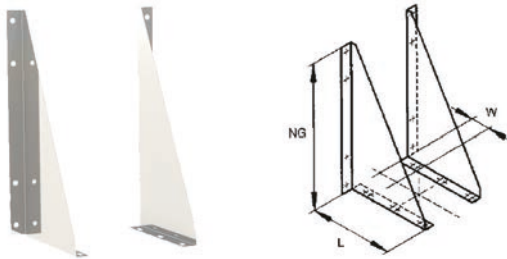

DN [mm]	80	100	113	130	150	180	200	225	250	300	355	400	450	500	600
NG[mm]	140	160	160	180	200	230	250	280	300	355	405	450	500	560	660
NG/L[mm]	430/238	475/261	475/261	500/280	530/300	580/330	610/352	650/377	680/400	760/452	840/503	900/549	980/600	1050/650	1200/750
kód	HAL 9.20.13 W = 50÷66 mm														
€/Kč	30,00/781	31,20/810	31,20/810	32,00/831	32,90/855	34,50/896	39,10/1017	41,20/1071	42,80/1112	46,70/1215	55,30/1437	68,80/1789	75,80/1971	83,10/2160	90,50/2354
kód	HAL 9.20.23 W = 100÷130 mm														
€/Kč	36,50/949	37,70/980	37,70/980	38,60/1002	39,60/1029	41,30/1073	46,40/1206	48,80/1269	50,40/1309	54,80/1425	64,00/1664	78,90/2051	86,20/2241	93,80/2439	101,60/2641
kód	HAL 9.20.33 W = 130÷160 mm														
€/Kč	40,20/1044	41,50/1078	41,50/1078	42,40/1103	42,40/1103	45,40/1180	51,00/1327	53,70/1396	55,40/1440	60,30/1567	70,40/1830	86,80/2256	94,80/2465	103,20/2683	111,70/2905

PLATŇA PRE MONTÁŽ NA STENOVÚ KONZOLU | DESKA PRO MONTÁŽ NA STĚNOVOU KONZOLU | WALL MOUNT BRACKET |
 WANDHALTERUNG | FALI TARTÓSZERKEZET



kód	HAL 9.22.13	
DN [mm]	NG[mm]	€/Kč
80	202	16,00/415
100	225	17,00/441
113	225	17,00/441
130	244	18,70/487
150	264	19,20/499
180	294	21,10/548
200	316	22,30/581
225	341	28,20/733
250	364	30,10/781
300	416	34,80/904
355	467	40,60/1056
400	513	45,80/1191
450	564	52,20/1357
500	614	63,20/1643
600	714	74,00/1925

INOX
ERS/EAD

INOX ERS/EAD

komponenty INOX | components INOX | komponente | INOX elemek
 bez povrchovej úpravy | uncoated | unbeschichtet | bevonat nélkül
 EN 1856 - T400 - N1 - W - V2 - L50060 - O(100) - L50100
 EN 1856 - T400 - N1 - D - V3 - L50060 - G(300) - L50100
 EN 1856 - T200 - P1 - W - V2 - L50060 - O(100) - L50100



Komponenty dymovodov - INOX trojvrstvý systém Kaminodur ERS/EAD teplotná trieda T400/T200

DIŠTANČNÝ PROFIL | DISTANČNÍ PROFIL | DISTANCE PROFILE | ENTFERNUNGSPROFIL | TÁVOLSÁG PROFIL

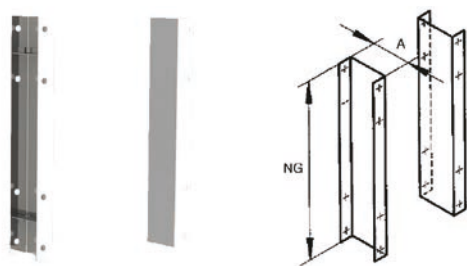

DN [mm]	80	100	113	130	150	180	200	225	250	300	355	400	450	500	600
NG[mm]	430	475	475	500	530	580	610	650	680	760	840	900	980	1050	1200
kód	HAL 9.24.13 A = 100 mm														
€/Kč	39,80/1034	40,80/1060	40,80/1060	41,30/1074	42,00/1091	43,10/1120	43,70/1137	48,70/1267	49,50/1288	51,70/1344	54,00/1403	55,70/1449	66,20/1722	68,80/1788	73,50/1910
kód	HAL 9.24.23 A = 150 mm														
€/Kč	43,00/1119	44,30/1153	44,30/1153	44,80/1164	45,90/1193	47,30/1231	48,20/1253	54,50/1416	55,50/1443	58,30/1516	61,20/1592	63,40/1649	76,90/1999	80,20/2084	86,40/2245
kód	HAL 9.24.33 A = 200 mm														
€/Kč	46,30/204	47,90/1245	47,90/1245	48,70/1267	49,80/1295	51,60/1341	52,60/1368	60,20/1566	61,50/1598	64,90/1687	68,50/1780	71,10/1850	87,60/2278	91,50/2380	99,20/2580
kód	HAL 9.24.43 A = 250 mm														
€/Kč	77,40/2011	80,10/2082	80,10/2082	81,10/2109	82,70/2150	85,40/2221	87,00/2263	98,70/2565	100,60/2616	105,90/2753	111,30/2895	115,50/3003	140,60/3656	146,70/3813	158,40/4119
kód	HAL 9.24.53 A = 300 mm														
€/Kč	80,90/2102	83,60/2173	83,60/2173	85,10/2213	86,90/2260	89,90/2338	91,80/2386	104,80/2724	107,00/2782	112,90/2935	119,00/3094	123,60/3215	151,90/3950	158,70/4127	172,10/4475
kód	HAL 9.24.63 A = 350 mm														
€/Kč	84,30/2192	87,30/2271	87,30/2271	89,00/2315	91,10/2368	94,40/2455	96,40/2507	110,80/2882	113,30/2947	119,90/3118	126,70/3294	131,80/3428	163,30/4245	170,80/4441	185,80/4830
kód	HAL 9.24.73 A = 400 mm														
€/Kč	87,80/2283	91,10/2369	91,10/2369	93,00/2417	95,20/2475	98,90/2571	101,10/2629	117,00/3041	119,70/3112	126,90/3299	134,40/3493	140,00/3639	174,60/4539	182,90/4755	199,40/5185

STREŠNÁ PODPERA | STŘEŠNÍ PODPĚRA | ROOF SUPPORT | DACH UNTERSTÜTZUNG | TETŐTÁMASZ

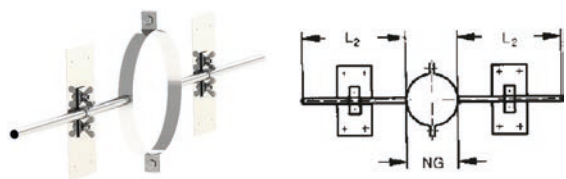

kód	HAL 9.11.33		
DN [mm]	NG[mm]	L ₂ [mm]	€/Kč
80	140	400	30,70/798
100	160	400	30,90/804
113	160	400	30,90/804
130	180	400	31,00/806
150	200	400	31,10/809
180	230	300	31,10/809
200	250	300	31,30/814
225	280	300	31,60/821
250	300	300	31,80/826
300	355	300	32,20/838
355	405	300	32,70/850
400	450	300	33,20/862
450	500	300	33,60/874
500	560	300	34,20/889
600	660	300	35,30/917

INOX
ERS/EAD

INOX ERS/EAD

komponenty INOX | components INOX | komponente | INOX elemek
bez povrchovej úpravy | uncoated | unbeschichtet | bevonat nélkül
EN 1856 - T400 - N1 - W - V2 - L50060 - O(100) - L50100
EN 1856 - T400 - N1 - D - V3 - L50060 - G(300) - L50100
EN 1856 - T200 - P1 - W - V2 - L50060 - O(100) - L50100



Komponenty dymovodov - INOX trojvrstvý systém Kaminodur ERS/EAD teplotná trieda T400/T200

3 BODOVÁ UPÍNACIA OBJÍMKA | 3 BODOVÁ UPÍNACÍ OBJÍMKA | 3 POINT CLAMPING COLLAR | 3-PUNKT-SPANNRING | 3 PONTOS SZORÍTÓ GALLÉR

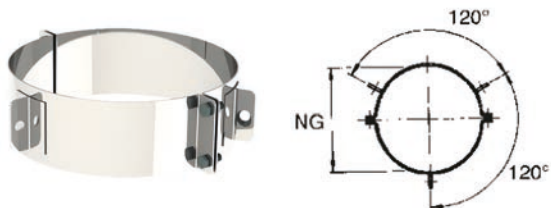

kód	HAL 9.11.53	
DN [mm]	NG[mm]	€/Kč
80	140	11,60/302
100	160	11,80/306
113	160	11,80/306
130	180	11,90/310
150	200	12,10/313
180	230	12,30/319
200	250	12,60/327
225	280	12,80/333
250	300	13,20/342
300	355	13,60/353
355	405	13,90/362
400	450	14,30/372
450	500	14,70/383
500	560	15,30/397
600	660	16,10/418



INOX
ERS/EAD



Komponenty dymovodov - izolované - PPs/INOX - teplotná trieda T120

RÚRA IZOLOVANÁ | TRUBKA IZOLOVANÁ | INSULATED PIPE | ROHR GEDÄMMT | SZIGETELT CSŐ

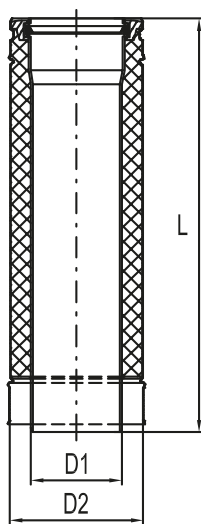

L [mm]	D1/D2 [mm]	80/130	110/160	125/180
250	kód	PN102BI_w	PN102GI_w	PN102DI_w
	€/Kč	24,10/650	26,30/710	29,30/790
500	kód	PN105BI	PN105GI	PN105DI
	€/Kč	28,90/780	31,80/860	36,60/990
1000	kód	PN110BI	PN110GI	PN110DI
	€/Kč	48,10/1300	53,70/1 450	59,00/1595

RÚRA S REVÍZNYM OTVOROM | TRUBKA S REVÍZNÍM OTVOREM | INSPECTION ELEMENT | KONTOLLROHR | EGYENES ELLENŐRZŐ IDOM

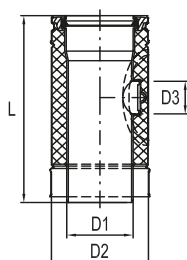

L [mm]	D1/D2 [mm]	80/130	110/160	125/180
300	kód	PN102BDI_w	PN102GDI_w	PN102DDI_w
	D3 (mm)	57	57	57
	€/Kč	54,80/1480	71,80/1940	73,00/1972

KOLENO IZOLOVANÉ | KOLENO IZOLOVANÉ | INSULATED ELBOW | BOGEN GEDÄMMT | SZIGETELT KÖNYÖKÖK

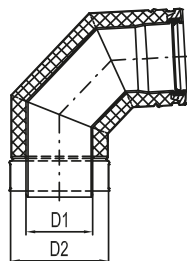

α	D1/D2 [mm]	80/130	110/160	125/180
93°	kód	PN190BI_w	PN190GI_w	PN190DI_w
	€/Kč	38,90/1050	41,50/1120	47,00/1270

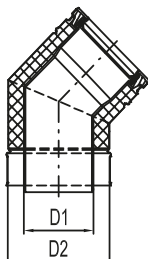

α	D1/D2 [mm]	80/130	110/160	125/180
45°	kód	PN145BI_w	PN145GI_w	PN145DI_w
	€/Kč	26,90/725	29,40/795	37,90/1025



Komponenty dymovodov - izolované - PPs/INOX- teplotná trieda T120

KOLENO S KONTROLNÝM OTVOROM | KOLENO S KONTROLNÍM OTVOREM | ELBOW WITH INSPECTION HOLE | BOGEN MIT REVISION-SÖFFNUNG | KÖNYÖK ELLENŐRZŐ LYUKKAL

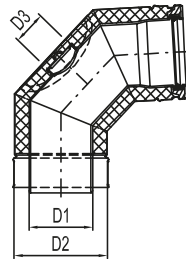

α	D1/D2 [mm]	80/130	110/160	125/180
93°	kód	PN190BDI_w	PN190GDI_w	PN190DDI_w
	D3 (mm)	57	57	57
	€/Kč	93,40/2525	102,50/2770	109,80/2970

T-KUS IZOLOVANÝ | T-KUS IZOLOVANÝ | INSULATED T-PIECE | T-STÜCK GEDÄMMT | SZIGETELT T-IDOMOK

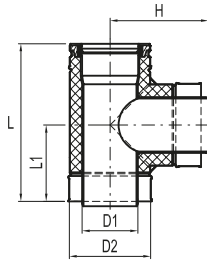

α	D1/D2 [mm]	80/130	110/160	125/180
90°	kód	PN521BI_w	PN521GI_w	PN521DI_w
	L (mm)	290	320	340
	L1 (mm)	145	160	170
	H (mm)	180	195	202
	€/Kč	49,20/1330	79,20/2140	95,80/2590

PÄTKOVÝ DIEL S PRISÁVANÍM | PATNÍ DÍL S PŘISÁVANÍM | BOTTOM PART WITH AIR INLET | UNTERTEIL MIT LUFTEINLASS | TALPAS ELEM LEVEGŐBESZÍVASAL

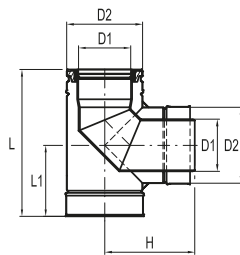

α	D1/D2 [mm]	80/130	110/160	125/180
90°	kód	PN509BKSI_w	PN509GKSI_w	PN509DKSI_w
	L (mm)	280	310	330
	L1 (mm)	135	150	160
	H (mm)	175	190	202
	€/Kč	69,70/1885	122,80/3320	144,80/3915

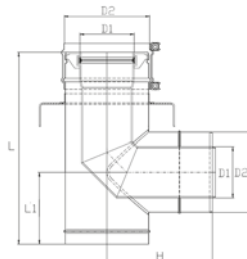

α	D1/D2 [mm]	80/130
90°	kód	PN509BKSI 2_w
	L (mm)	300
	L1 (mm)	112
	H (mm)	165
	€/Kč	84/2184



Komponenty dymovodov - izolované - PPs/INOX - teplotná trieda T120

NAPOJENIE | NAPOJENÍ | SINGLE/TWIN WALL JUNCTION | VERBINDUNGSTEIL | CSATLAKOZÓ IDOML

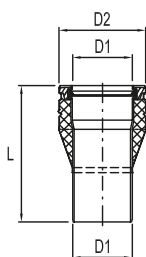

L [mm]	D1/D2 [mm]	80/130	110/160	125/180
250	kód	PN531BZ_w	PN531GZ_w	PN531DZ_w
	€/Kč	27,60/745	30,90/835	36,80/995

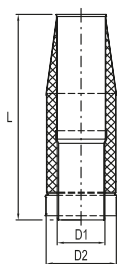
KOMÍNOVÁ HLAVICA-IZOLOVANÁ | KOMÍNOVÁ HLAVICE-IZOLOVANÁ | INSULATED CONICAL TERMINATION | CAPKAMINHAUBE
GEDÄMMT | SZIGETELT KÉMÉNY FEJ

L [mm]	D1/D2 [mm]	80/130	110/160	125/180
500	kód	PN517BHI_w	PN517GHI_w	PN517DHI_w
	€/Kč	45,20/1220	48,10/1300	51,60/1395

VYNÁŠACÍ DIEL | VYNÁŠECÍ DÍL | SUPPORT ELEMENT | STÜTZELEMENT | TARTÓ ELEM

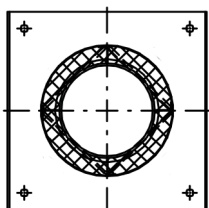
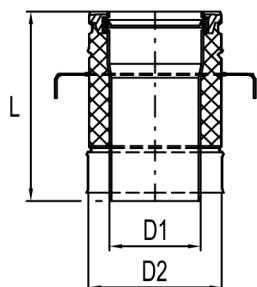

L [mm]	D1/D2 [mm]	80/130	110/160	125/180
230	kód	PN500BVI_w	PN500GVI_w	PN500DVI_w
	€/Kč	39,40/1064	42,20/1140	45,20/1220

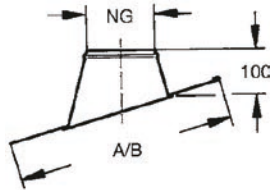

Komponenty dymovodov - izolované - PPs/INOX- teplotná trieda T120

PRECHODKA PRE ŠIKMÚ STRECHU 5°-27° | PŘECHODKA PRO ŠIKMOU STŘECHU 5°-27° | SLIP FOR SLOPING ROOF 5°-27° | SLIP FÜR
SCHRÄGDACH 5°-27° | FERDE TETŐ BORÍTÁS 5°-27°

kód	FGS 6.30.15		
DN [mm]	NG[mm]	A/B	€/Kč
80	180	665/490	35,10/913
110	180	665/490	35,10/913
125	200	680/515	37,30/971

OCHRANNÝ VENIEC | OCHRANNÝ VĚNEC | PROTECTIVE WREATH | SCHUTZKRANZ | VÉDŐ GALLÉR

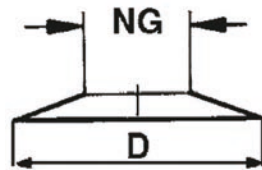

kód	WTK 6.52.03 A			
DN [mm]	NG[mm]	L[mm]	D [mm]	€/Kč
80	130	100	340	10,40/270
110	160		380	10,90/284
125	180		380	11,30/293

STENOVÝ DRŽIAK | STĚNOVÝ DRŽÁK | WALL BRACKET | WANDHALTERUNG | FALI BILINCS

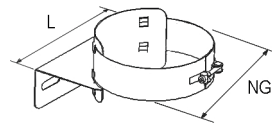

L [mm]	DN/NG [mm]	80/130	110/160	125/180
131	kód	N551F		
161	kód		N551H	
181	kód			N551K
	€/Kč	14,20/384	14,50/390	14,80/400

STENOVÁ KONZOLA | STĚNOVÁ KONZOLA | WALL CONSOLE | WANDKONSOLE | FALI KONZOL

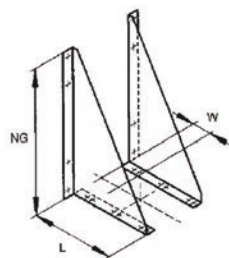

kód	HAL 9.20.13 w		
W=50-60 mm			
DN [mm]	NG[mm]	NG/L[mm]	€/Kč
80	130	430/238	30,00/781

kód	HAL 9.20.13		
W=50-60 mm			
DN [mm]	NG[mm]	NG/L[mm]	€/Kč
110	160	475/261	31,20/810
125	180	500/280	32,00/831



Ceny sú uvádzané bez DPH.

Nákresy a fotografie výrobkov sú len ilustračné. Z dôvodu technických alebo obchodných potrieb, v snahe o neustále zlepšovanie akosti, si výrobca vyhradzuje právo svoje produkty modifikovať bez predchádzajúceho upozornenia. Výrobca nenesie žiadnu zodpovednosť za prípadné chyby alebo nepresnosti v obsahu tohto katalógu.

Ceny jsou uváděny bez DPH.

Nákresy a fotografie výrobků jsou pouze ilustrační. Z důvodu technických nebo obchodních potřeb, ve snaze o neustálé zlepšování jakosti, si výrobce vyhradzuje právo své produkty modifikovat bez předchozího upozornění. Výrobce nenesé žádnou odpovědnost za případné chyby nebo nepřesnosti v obsahu tohoto katalogu.

Prices excluding VAT.

Drawings and product photographs are only illustrative. The manufacturer reserve the rights to modify our products without prior notice, due to technical or business needs, in the pursuit of continuous improvement of quality. The manufacturer assumes no responsibility for any errors or inaccuracies in the content of this catalogue.

Alle Preise sind ohne MWSt.

Abbildungen und Zeichnungen ähnlich. Der Hersteller kann die Produkte aus technischen oder Vertriebsgründen ohne vorheriger Meldung modifizieren und verbessern. Alle Angaben zu Preisen, Produkttexten, Produktbildern sind ohne Gewähr, Irrtümer und technische Änderungen vorbehalten.

Az árak ÁFA nélkül.

Rajzok és a termék fényképekkel csupán szemléltető. A gyártó fenntartja magának a jogot, hogy technikai vagy üzleti igénye nélkül, előzetes értesítés nélkül módosítsa termékeinket a minőség folyamatos javítása érdekében. A gyártó nem vállal semmilyen felelősséget a katalógus tartalmában fellelő hibákért vagy pontatlanságokért.

REAGUJEME NA INDIVIDUÁLNE POŽIADAVKY ZÁKAZNÍKOV

S ohľadom na súčasné nároky v oblasti výroby komínových komponentov pre plynové kotle, reagujeme aj na individuálne požiadavky našich zákazníkov. Sme schopní spracovať návrh výrobku na základe konkrétnych požiadaviek, čím vieme uspokojiť aj dopyt po výrobkoch nad rámec tohto katalógu.

S ohledem na současné nároky v oblasti výroby komínových komponentů pro plynové kotle, reagujeme i na individuální požadavky našich zákazníků. Jsme schopni zpracovat návrh výrobku na základě konkrétních požadavků, čímž víme uspokojit i poptávku po výrobcích nad rámec tohoto katalogu.

Our company also respond to the individual requirements of our customers, with respect to the current demands in the field of flue components production for gas boilers. We are able to process product design on the basis of specific requirements, so we can also satisfy demand for products beyond this catalog.

Unsere Firma ist bereit ihre Produkte aufgrund kundenspezifischen Anfragen modifizieren oder neu entwickeln. Wir produzieren und liefern auch die Produkte außer Standardsortiment in dieser Preisliste genannt.

Cégünk ügyfelei egyedi igényeinek kielégítésére is reagál, tekintettel a gázkazánok égéstermék-elvezetésére vonatkozó jelenlegi követelményekre. Képesek vagyunk feldolgozni a terméktervezést specifikus követelmények alapján, így kitudjuk elégíteni a katalóguson kívüli termékek iránti keresletet is.

Všeobecné obchodné podmienky spoločnosti

I.G.C.STROJAL s.r.o., zapísanej v OR OS Banská Bystrica, odd.: Sro, vložka č.10017/S, IČO: 35 763 361
So sídlom v Žiari nad Hronom, Priemyselná 12/939, PSČ: 965 63

I. Úvodné ustanovenia

Nasledujúce všeobecné obchodné podmienky, v ďalšom texte len „VOP“ sú prílohou rámcovej kúpnej zmluvy, a teda jej neoddeliteľnou súčasťou a tvoria jej obsah. Odlišné dojednania v rámcovej zmluve majú pred znením týchto obchodných podmienok prednosť.

Kupujúci je povinný zabezpečiť, aby osoby oprávnené konať v jeho mene alebo s jeho poverením toto svoje oprávnenie a svoju totožnosť preukázali preukazným spôsobom v súlade so zákonom NR SR č.428/2002 Z.z. o ochrane osobných údajov v znení neskorších predpisov s ohľadom na § 7 ods.4 písm.b) a §10 ods.4.

Ak na strane kupujúceho vystupuje právnická osoba, je táto povinná predložiť predávajúcemu výpis z obchodného registra, prípadne iný doklad, preukazujúci existenciu tejto právnickej osoby.

Ak je kupujúcim podnikateľ – fyzická osoba, predloží pri prvom uzatváraní zmluvy overenú kópiu oprávnenia na podnikanie a potvrdenie o založení účtu.

II. Definovanie pojmov

Zmluvné strany sú predávajúci a kupujúci.

Predávajúci je spoločnosť I.G.C.STROJAL s.r.o., zapísaná v OR OS Banská Bystrica, odd.: Sro, vložka č.10017/S, IČO: 35 763 361 so sídlom v Žiari nad Hronom, Priemyselná 12/939, PSČ: 965 63

Kupujúci je obchodná spoločnosť alebo podnikateľ, ktorý uzatvára s predávajúcim rámcovú kúpnu zmluvu alebo kúpnu zmluvu na tovar z ponuky predávajúceho v súvislosti s vlastnou činnosťou. Za kupujúceho pre účely týchto obchodných podmienok sa nepovažuje spotrebiteľ.

Tovar je hnutelná vec z ponuky predávajúceho. Ponuka predávajúceho je zverejnená v katalógu výrobkov a/alebo v cenníku výrobkov a/alebo na internetovej stránke predávajúceho a/alebo inak jednoznačne poskytnutá. Tovar je definovaný názvom, kódom a parametrami.

Rámcová zmluva je písomná dohoda predávajúceho a kupujúceho o budúcich kúpnych zmluvách.

Kúpna zmluva je zmluva v ktorej sa zaväzuje predávajúci dodať tovar kupujúcemu v množstve podľa objednávky za dohodnutých podmienok. Zároveň sa kupujúci zaväzuje zaplatiť predávajúcemu za prijatý tovar dohodnutú kúpnu cenu za podmienok stanovených rámcovou kúpnu zmluvou alebo týmito VOP.

III. Kúpna zmluva

Kúpna zmluva je uzavretá potvrdením záväzku predávajúceho dodať tovar kupujúcemu podľa jeho objednávky.

Objednávka kupujúceho musí obsahovať:

1. označenie zmluvných strán vrátane obchodného názvu, IČO, DIČ a sídla
2. označenie tovaru v názvosloví predávajúceho a s kódom tovaru podľa predávajúceho
3. množstvo tovaru
4. miesto plnenia
5. čas plnenia
6. odchýlky od obvyklých podmienok, napr. zmena balenia alebo značenia tovaru



Tieto údaje sú platnou súčasťou kúpnej zmluvy, pokiaľ sa zmluvné strany nedohodnú inak. Predávajúci potvrdí kupujúcemu svoj záväzok dodať tovar podľa objednávky kupujúceho. Predávajúci tak urobí do 5 pracovných dní od prijatia objednávky.

Písomná forma je jediná záväzná forma pre všetky úkony. Kupujúci je povinný odosielať správy elektronicky na dohodnutú alebo zverejnenú mailovú adresu. Ústne prípadne telefonické dojednania musia byť bezodkladne potvrdené písomnou formou.

IV. Kúpna cena

Kúpna cena za jednotlivé tovary je stanovená predávajúcim v cenníku. Pokiaľ dôjde k zmene cenníka, platná je cena aktuálna ku dňu uzavretia kúpnej zmluvy. Cenník je dostupný na internetovej stránke www.igc.sk, v tlačenej forme v mieste sídla predávajúceho a na vyžiadanie ho zašle predávajúci poštou kupujúcemu.

Zľavy z cenníkových cien alebo iné dojednané odchýlky môžu byť určené osobitne rámcovou zmluvou na základe objednávaných množstiev, konkurenčných cien a dohodnutých platobných podmienok.

V. Platobné podmienky

Kupujúci je povinný uhradiť kúpnu cenu predávajúcemu bezhotovostným prevodom na bankový účet predávajúceho, ktorý je uvedený na faktúre – daňovom doklade. V prípade osobného odberu je možná úhrada v hotovosti.

Splatnosť faktúry je 14 dní odo dňa vystavenia faktúry, pokiaľ sa zmluvné strany nedohodnú písomne inak. Za deň uskutočnenia platby je považovaný deň pripísania finančných prostriedkov na účet predávajúceho.

Predávajúci je oprávnený požadovať úhradu úroku z omeškania vo výške 0,05% z dlžnej sumy za každý deň omeškania platby za dodaný tovar.

Predávajúci je oprávnený odstúpiť od zmluvy a požadovať vydanie tovaru späť, pokiaľ kupujúci mešká s úhradou kúpnej ceny. Predávajúci je oprávnený požadovať od kupujúceho úhradu nákladov na späťvzatie takéhoto tovaru.

VI. Dodanie tovaru

Predávajúci sa zaväzuje dodať tovar na miesto plnenia v čase dohodnutom v kúpnej zmluve.

Kupujúci vyznačí prevzatie tovaru na dodacom liste podpisom poverenej osoby.

Kupujúci je povinný bez zbytočného odkladu skontrolovať stav prijatého tovaru, jeho množstvo, druh, kompletnosť a akosť s ohľadom na objednávku.

Kupujúci je povinný oznámiť všetky vady a odchýlky tovaru od parametrov deklarovaných predávajúcim, pokiaľ tieto mohol zistiť obvyklým zisťovaním pri prevzatí tovaru. Odchýlky je povinný kupujúci zaznamenať do dodacieho listu alebo prepravného listu prepravcu. Pokiaľ to nie je možné, oznámi vady bezprostredne po ich zistení predávajúcemu písomnou formou.

VII. Vlastnícke právo k tovaru

Vlastnícke právo k tovaru prechádza z predávajúceho na kupujúceho momentom zaplatenia kúpnej ceny. Pokiaľ nedôjde k prechodu vlastníckeho práva k tovaru na kupujúceho, je tovar vo vlastníctve predávajúceho a kupujúci má práva uschovávateľa na vlastné náklady.

VIII. Nebezpečenstvo škody

Z kupujúceho na predávajúceho prechádza nebezpečenstvo škody na tovare prevzatím tovaru. Pokiaľ plní predávajúci svoju povinnosť dodať tovar prostredníctvom tretej osoby – dopravcu, prechádza nebezpečenstvo škody na tovare na kupujúceho odovzdaním tovaru dopravcovi.



IX. Vady

Predávajúci dodáva tovar v obvyklej akosti a deklarovanom prevedení v dohodnutom množstve. Za vadu sa považuje dodanie tovaru v inej akosti, v inom prevedení alebo v inom množstve ako bolo dohodnuté.

Právo z vád tovaru má kupujúci, pokiaľ oznámi predávajúcemu vady, ktoré je možné zistiť včasnou prehliadkou alebo obvyklým zisťovaním pri prevzatí tovaru a toto urobí do 14 dní od prevzatia tovaru.

Predávajúci je povinný uskutočniť náhradné plnenie alebo odstránenie vád do 30 dní odo dňa oznámenia vád kupujúcim.

Kupujúci je povinný umožniť predávajúcemu manipuláciu s tovarom za účelom zistenia skutočného stavu tovaru a odstránenia vady. Odstránením vady môže byť aj oprava tovaru tak, aby spĺňal deklarované alebo dohodnuté parametre a akosť.

Pokiaľ nie je možné opraviť vadný tovar, prípadne by bola oprava tovaru neprimerane nákladná, má kupujúci právo požadovať dodanie náhradného tovaru alebo zľavu z kúpnej ceny za tovar.

Montáž výrobkov I.G.C. môže vykonávať len odborne spôsobilá osoba. V prípade neodbornej montáže, spoločnosť I.G.C. nezodpovedá za vzniknuté škody.

X. Záruka

Predávajúci zaručuje akosť tovaru po dobu 60 mesiacov odo dňa dodania.

Ďalej poskytuje predávajúci dodatočnú záruku na akosť tovaru inštalovaného v rámci komínového systému pod podmienkou, že tovar bol inštalovaný autorizovanou osobou v oblasti komínov, ktorá absolvovala preškolenie u predávajúceho na montáž prvkov, ktoré sú tovarom predávajúceho. Podmienkou pre uplatnenie dodatočnej záruky je dodanie podmienok uvedených v Reklamačnom poriadku predávajúceho.

Dodatočnú záruku na akosť tovaru inštalovaného v rámci komínového systému poskytuje predávajúci po dobu 60 mesiacov odo dňa montáže potvrdeného autorizovanou osobou, ktorá systém montovala.

XI. Záverečné ustanovenia

Tieto VOP sú platné od 1. 11. 2019.

Predávajúci si vyhradzuje právo zmeniť VOP. Zmenu VOP je predávajúci povinný oznámiť kupujúcemu bez odkladu.

Všetky zmeny v zmluvných vzťahoch musia byť uskutočnené písomnou formou.

Zmluvné strany sa zaväzujú zachovať mlčanlivosť o všetkých náležitostiach, okolnostiach a obsahu vzájomných zmluvných vzťahov voči tretím osobám. Rovnako sú povinné zachovať mlčanlivosť o informáciách mimo zmluvných vzťahov, ktoré by mohli získať alebo by sa s nimi mohli zoznámiť pri plnení vzájomných zmluvných záväzkov. Všetky informácie o technológii, obchodných partneroch, hospodárskych výsledkoch, činnosti zmluvných strán, ich majetku a o personálnych vzťahoch sú považované za dôverné, pokiaľ nie sú získané z verejne dostupných zdrojov.

Všetky kúpne zmluvy a rámcové kúpne zmluvy sú uzavreté výlučne podľa VOP, pokiaľ sa zmluvné strany nedohodnú inak. V prípade pochybností sa vzťahy zmluvných strán riadia slovenskou verzou týchto Všeobecných zmluvných podmienok a právnymi predpismi platnými na území Slovenskej republiky.

Ing. Miroslav Brumlich
konateľ spoločnosti

Ing. Jozef Zúbrik
konateľ spoločnosti



OZNAČENIE KOMÍNA (AL) SPECIFICATION OF THE CHIMNEY (AL)

Jednovrstvový EN 1856-1 — T200 — P1 — D — V1 — L10200+13150 — O70
Single wall

Dvojrvtvový EN 1856-1 — T200 — P1 — D — V1 — L10200+13150+11090 — O50
Double wall - concentric

Trojvrstvový EN 1856-1 — T200 — P1 — D — V1 — L10200+13150+11090 — O20
Three wall - insulated

Jednovrstvový EN 1856-1 — T300 — P1 — D — V1 — L10200+13150 — O100
Single wall

Dvojrvtvový EN 1856-1 — T300 — P1 — D — V1 — L10200+13150+11090 — O70
Double wall - concentric

Trojvrstvový EN 1856-1 — T300 — P1 — D — V1 — L10200+13150+11090 — O50
Three wall - insulated

Číslo normy
Reference standard

Teplotná trieda do (°C)
Temperature class

Tlaková trieda (do 200 Pa)
Pressure class

Trieda odolnosti proti kondenzátu (suchá prevádzka)
Condensate resistance class

Odolnosť proti korózii (Vm)
Corrosion resistance class

Špecifikácia materiálu komínovej vložky (typ+hrúbka v násobku 0,01 mm)
Flue liner material specification

Trieda odolnosti pri vyhorení sadzí (O-nieje odolný) a minimálna vzdialenosť od horľavých materiálov (v mm)
Soot fire resistance and distance to combustible material

OZNAČENIE KOMÍNA (PPs) SPECIFICATION OF THE CHIMNEY (PPs)

Jednovrstvový EN 14471 — T120 — P1 — O — W — 1 — O10 — I — E — L
Single wall

Dvojrvtvový EN 14471 — T120 — P1 — O — W — 1 — O00 — I — E — L0
Double wall - concentric

Trojvrstvový EN 14471 — T120 — P1 — O — W — 1 — O00 — I — E — L0
Three wall - insulated

Číslo normy
Reference standard

Teplotná trieda
Temperature class

Tlaková trieda
Pressure class

Odolnosť proti vyhoreniu sadzí
Soot fire resistance class

Trieda odolnosti proti kondenzátu
Condensate resistance class

Odolnosť proti korózii
Corrosion resistance class

Vzdialenosť od horľavých materiálov
Distance to combustible materials

Umiestnenie
Flue system location

Reakcia na oheň
Reaction to fire

Trieda opláštenia
Protection class

Obchodná centrála a výroba

I.G.C.STROJAL s.r.o.
Priemyselná 12/ 939, 965 63 Žiar nad Hronom
Slovak republic
+421 / 456 78 90 50
info@igc.sk
www.igc.sk

Obchodné zastúpenie

SR, HU - Bc. Gabriel Klotton
+421 / 903 711 469
klotton@igc.sk

CZ - Musílek Tomáš
Žerotínova 129, 789 69 Postrelmov
+420 / 724 22 42 12
musilek.igc@seznam.cz
www.igc.cz

Vydané 11/2019

Ceny sú platné od 1. 11. 2019 do vydania nového katalógu.

Váš dodávateľ komínových systémov IGCS

